



Straumann® Bone Level Prosthetic Procedures
Basic Information

Contents

1. General information – Straumann® Bone Level and Bone Level Tapered Implant System	1
1.1 Straumann® Bone Level (BL) and Bone Level Tapered (BLT) Implants	1
1.2 CrossFit® Connection	2
1.3 Color code for CrossFit®	4
2. General information – Straumann® Bone Level X Implant System	6
2.1 Straumann® BLX Implants	6
2.2 TorcFit™ connection	7
2.3 Color code for TorcFit™	9
2.4 Prosthetic components overview for TorcFit™ Implants	10
3. Prosthetic portfolio overview	14
3.1 Prosthetic options	14
3.2 Abutment Overview	16
4. Preoperative planning	18
4.1 Wax-up/Set-up	18
4.2 X-ray template with reference spheres	18
4.3 Custom-made drill template – BL/BLT only	19
5. Soft tissue management	20
5.1 Soft tissue management solutions	20
5.2 Prefabricated Healing Abutment – Prosthetic procedure	21
5.3 Overview of suitable healing abutments for CrossFit® abutments	23
5.4 Overview of Consistent Emergence Profiles™ for TorcFit™ abutments	26
5.5 Prefabricated healing abutment	29
5.6 Customizable Healing Abutment	30
5.7 Temporary Abutment – Polymer with titanium-alloy inlay (VITA CAD-Temp®/TAN)	32
5.8 Temporary abutment – Titanium alloy (TAN)	39
5.9 Immediate Temporary abutment - Titanium alloy (TAN)	42
6. Impression taking	46
6.1 Options for impression taking	46
6.2 Open-tray impression	47
6.3 Closed-tray impression	51
6.4 Bite registration	55

7. Restoration	57
7.1 CrossFit® Plan Set/Plan abutment	57
7.2 TorcFit™ Plan abutment	59
7.3 Anatomic Abutment	60
7.4 Gold Abutment for crown	66
7.5 Gold abutment for bridge	78
7.6 Cementable abutment	89
7.7 Straumann® Screw-retained Abutments	106
7.8 LOCATOR® Abutment	131
8. Aids and instruments	147
8.1 SCS Screwdriver	147
8.2 Polishing Aid	147
8.3 Ratchet and Torque Control Device	148
8.4 Assembling the Ratchet and the Torque Control Device	150
8.5 Tightening an abutment to 35 Ncm	152
9. Cleaning, Disinfection and Sterilization	154
10. Important guidelines	155

Purpose of this guide

This guide describes the essential steps required for the fabrication and insertion of prosthetic restorations for Straumann® Bone Level Implants.

For detailed information regarding implantation and soft tissue management, please refer to the *Straumann® Dental Implant System, Basic Information (702084/en)* for BL and BLT implants and *Straumann® BLX Implant System, Basic Information (702115/en)* for BLX implants.

Note: Procedures that apply for technicians in the dental lab are marked green.
Procedures that apply for prosthodontists are marked grey:

- Lab procedure
- Prosthetic procedure

Not all products shown are available in all markets.

All products shown in this guide are for single use only if not indicated otherwise.

1. General information – Straumann® Bone Level and Bone Level Tapered Implant System



1.1 Straumann® Bone Level (BL) and Bone Level Tapered (BLT) Implants

The Straumann® Bone Level Implant provides you with a solution for all bone level treatments – Straumann expertise and quality built in. Its design is based on the latest technology and scientific know-how in implant dentistry. Moreover, it respects key biological principles, brings predictable esthetic results and offers simple handling in all indications.

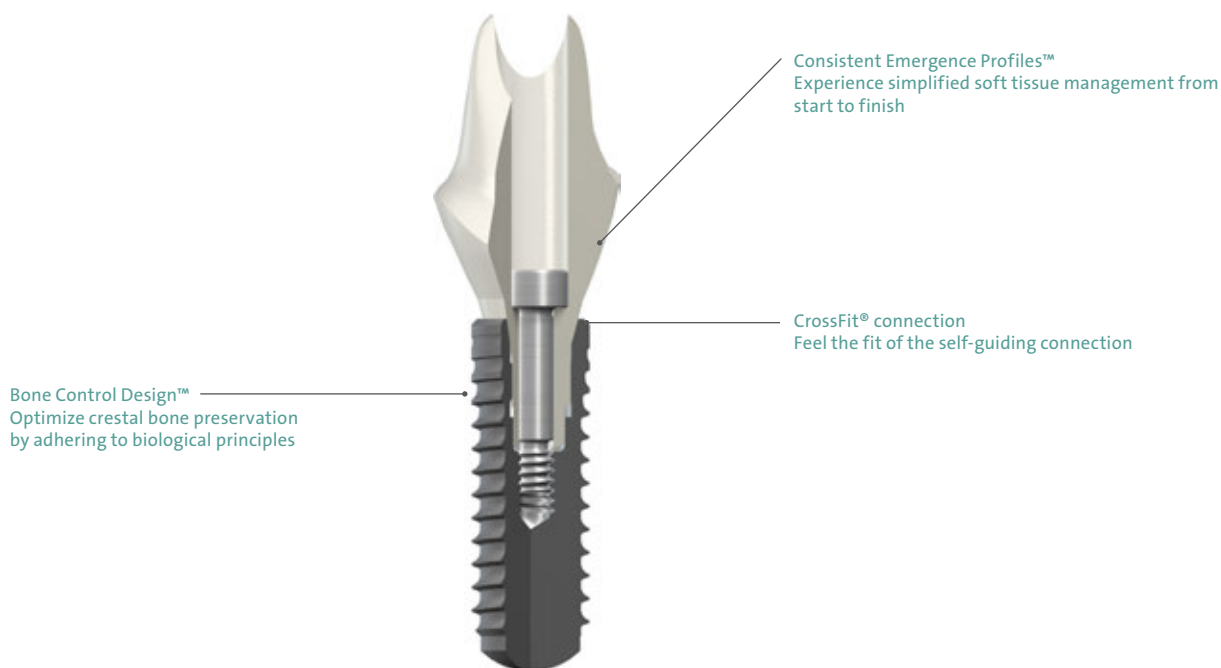

Bone Control Design™

The unique Bone Control Design™ is based on key biological principles and thorough scientific research to support crestal bone preservation and stable soft tissue margins. It features the following strengths:

- Fast osseointegration with the SLActive® surface technology
- Optimal transmission of forces into the bone through the biomechanical implant design
- Consideration of the biological distance with a horizontal distance of micro gap to bone
- Reduction of micro movements while controlling the micro gap through a conical connection

Consistent Emergence Profiles™

The prosthetic components of the Straumann® Bone Level Implant line are designed to facilitate highly esthetic restorations that perfectly mimic natural teeth. These implant line components, designed to match the abutment profiles, allow you to easily attain esthetic results through soft tissue management.

CrossFit® connection

The prosthetic connection is intuitive, self-guiding and easy to grasp. The CrossFit® connection

- provides a clear-cut insertion through the guidance by 4 grooves and the deep, conical connection.
- ensures precision against rotation through orthogonal fit between implant and abutment.
- gives prosthetic flexibility with mechanical long-term stability through its conical connection.



1.2 CrossFit® Connection

The Straumann® Bone Level Implant features an intuitive implant-abutment connection that is self-guiding and enables simple positioning. It allows clear-cut insertion with all components and provides outstanding protection against rotation as well as long-term stability.

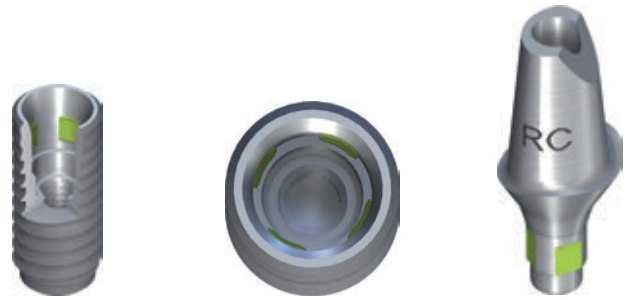

Precision and simplicity: 4 grooves

The CrossFit® connection features 4 grooves for the repositioning of prosthetic components.

This configuration is characterized by:

- simple implant alignment
- clear-cut and guided component insertion
- flexibility in the placement of angled prosthetic components
- optimal protection against rotation ensured by orthogonal implant-abutment fit



Internal connection viewed from above, showing the 4 internal grooves.

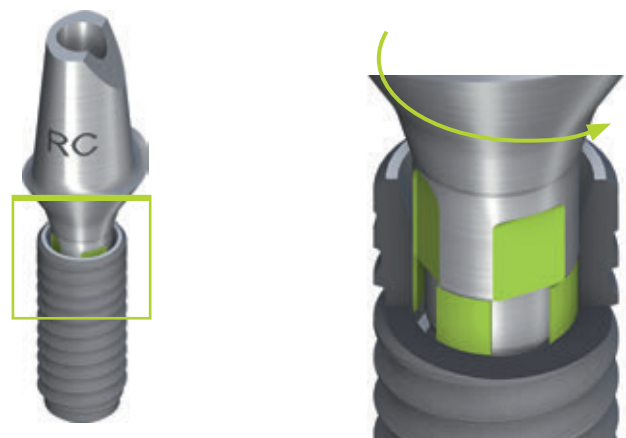

Abutment insertion, step 1.
The abutment is placed on the 4 grooves in the implant.

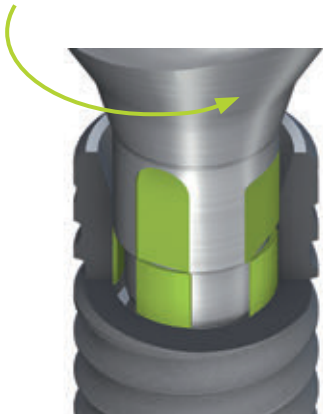

Abutment insertion, step 2.
The abutment is turned in until it is aligned with the 4 implant grooves.

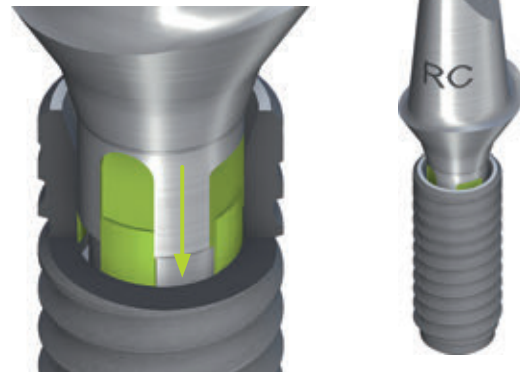

Abutment insertion, step 3.
The abutment then falls into the final position.

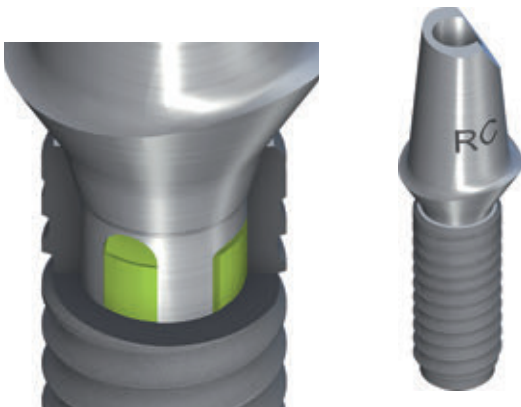

Abutment in place, showing the precise orthogonal fit between implant and abutment.

Reliability and flexibility: Conical connection

The CrossFit® connection features a cone with improved mechanical properties, providing more flexibility for prosthetic treatments.







The conical prosthetic connection provides:













- reduced micro movements and minimized microgap
- outstanding mechanical long-term stability and optimized stress distribution
- exact implant-abutment fit
- simplified impression taking even with divergently positioned implants

1.3 Color code for CrossFit®

The Straumann® Bone Level Implant line has a simple and consistent color coding and laser markings for quick and precise identification of secondary parts, surgical instruments and auxiliaries. This concept simplifies the communication substantially between the individuals involved in the treatment process.

The following scheme illustrates the above mentioned color codings and laser markings:

Connection	Implant Ø	Instruments	Implant	Closure screw
Narrow CrossFit® (NC)	3.3 mm			
Regular CrossFit® (RC)	4.1 mm 4.8 mm			
Laser marked (NC/RC)		•		•
Color-coded				•

Healing abutment	Impression post	Implant analog	Temporary abutment, VITA CAD-Temp®	Abutment
				
				
<p style="text-align: center;">•</p>				<p style="text-align: center;">•</p>
<p style="text-align: center;">•</p>	<p style="text-align: center;">•</p>	<p style="text-align: center;">•</p>	<p style="text-align: center;">•</p>	<p style="text-align: center;">•</p>
			 <p style="text-align: center;">Screw head</p>	 <p style="text-align: center;">Screw head</p>

2. General information – Straumann® Bone Level X Implant System



2.1 Straumann® BLX Implants

The Straumann® BLX Implant System offers bone level implants (BLX) that are designed for high primary stability and immediate treatment procedures.

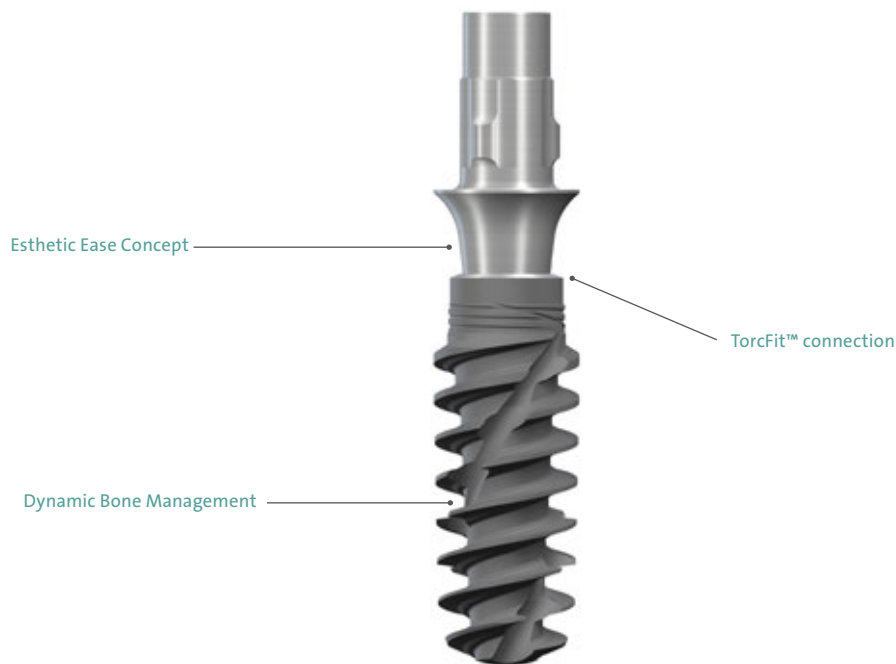

Dynamic Bone Management

- The unique “Cut, Collect, Condense” properties redistribute native bone along the implant leading to high bone-to-implant contact
- Bi-directional cutting elements give control over insertion torque to achieve optimal primary stability in all bone types
- Reduced implant neck avoids overcompression of crestal bone
- Enhanced drill design with minimized heat generation for less drill steps

Esthetic Ease Concept

- One connection for simplified restorative workflows
- Slim and under-contoured abutment designs for predictable esthetic outcomes
- Consistent emergence profile for easy soft tissue conditioning

TorcFit™ connection

- Reduced 7° cone angle provides a tight conical seal and prosthetics with slim emergence profiles
- Flat top for auxiliaries for accurate impression taking.
- Outer shoulder for bridges and crowns with wide emergence profiles.

2.2 TorcFit™ connection

The Straumann® BLX Implant features the intuitive TorcFit™ connection. This connection supports self-guiding insertion, for clear-cut tactile feedback. Six positions enable a simple yet flexible alignment and outstanding protection against rotation.

All BLX Implants have the same inner geometry regardless of the diameter of the implant. This allows the use of one set of prosthetic components (“RB/WB abutments”) and simplifies the prosthetic steps. In addition, a wide emergence profile can be created on top of WB implants (“WB abutments”).

Improved Torx with six positions:

- Allows transmission of high torques
- Simple yet flexible implant and abutment alignment

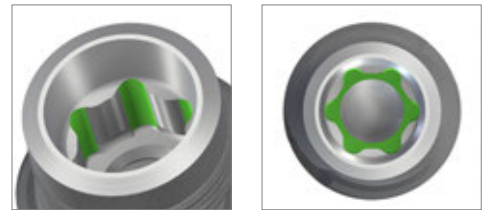

7° conical prosthetic connection:

- High mechanical stability and stress distribution
- Exact implant-abutment fit
- Narrow emergence profile creates space for soft tissues
- Clear feedback of final position by friction fit

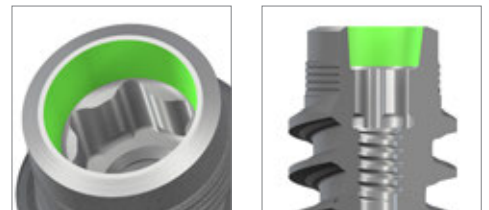

22.5° shoulder prosthetic connection:

- High mechanical stability
- Exact implant-abutment fit
- Extra wide emergence profiles (implants with diameter >5.0 mm)
- Divergence compensation for bridges



Flat Top portion:

- High accuracy for impression components
- Flat sealing for healing and temporary components to protect inner conus.

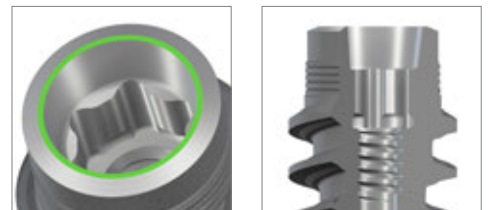

Same inner geometry regardless of the diameter of the implant

- A single prosthetic range to manage all implant diameters („RB/WB“)
- Simplified prosthetic steps
- Same implant driver for all implants

Precise machined shoulder for optional wide emergence profile (Diameter >5.0)

- Free choice of implant regardless of prosthetic volume to restore.

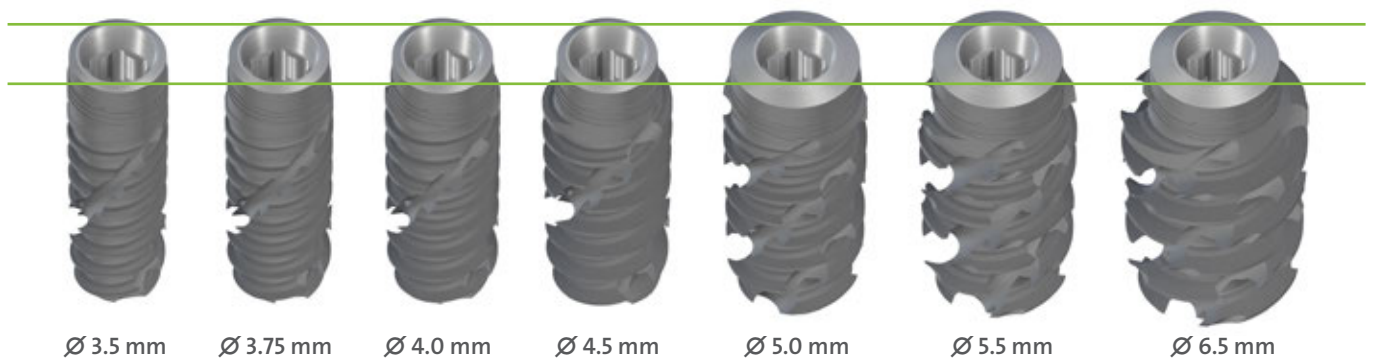





2.3 Color code for TorcFit™

The Straumann® BLX Implant System has a simple and consistent color coding and laser markings for quick and precise identification of secondary parts, and auxiliaries.

This concept allows for correct identification of matching components, and simplifies the communication between the individuals involved in the treatment process.

Components color coded magenta, can be used on all BLX implants \varnothing 3.75 until \varnothing 6.5.

Components color coded brown can only be used on BLX implants \varnothing 5.5, and \varnothing 6.5.

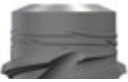

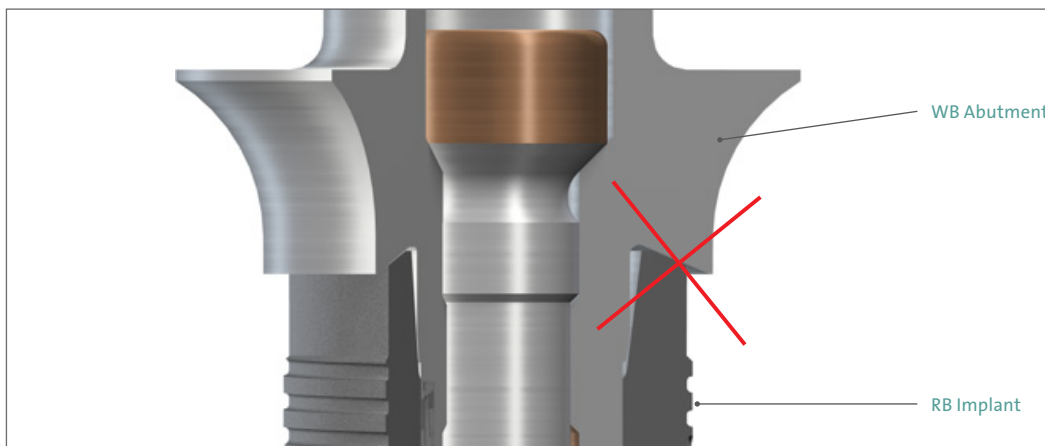





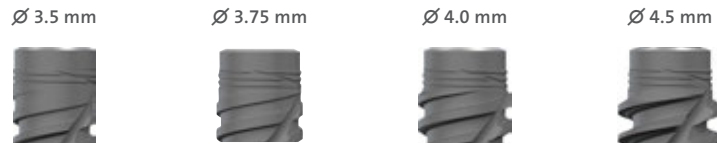





















Prosthetic Color		Implant Diameters	Implant Base
	 RB/WB	\varnothing 3.5 mm \varnothing 3.75 mm \varnothing 4.0 mm \varnothing 4.5 mm \varnothing 5.0 mm \varnothing 5.5 mm \varnothing 6.5 mm	 RB WB
	 WB	\varnothing 5.0 mm \varnothing 5.5 mm \varnothing 6.5 mm	 WB



No WB Abutments on RB Implants!

2.4 Prosthetic components overview for TorcFit™ Implants



Impression taking Implant Analogs	Ø 3.5 mm				Ø 3.75 mm		Ø 4.0 mm		Ø 4.5 mm	
	Abutment diameter									
	Ø 3.8 mm									
Gingiva Height  GH 0.75 mm										
Gingiva Height  GH 1.5 mm	 062.4934	 062.4981	 062.4501	 062.4410		 062.4944	 062.4972	 062.4982	 062.4961*	
Gingiva Height  GH 2.5 mm	 062.4935	 062.4502	 062.4507			 062.4945				
Gingiva Height  GH 3.5 mm	 062.4936	 062.4503	 062.4508			 062.4946				
Gingiva Height  GH 4.5 mm			 062.4504	 062.4509						
Gingiva Height  GH 5.5 mm			 062.4505	 062.4510						
Gingiva Height  GH 6.5 mm			 062.4506	 062.4511						
Gingiva Height  GH 7.5 mm			 062.4512							



065.0021



065.0023

Ø 4.5 mm		Ø 6.0 mm	
			
 062.47225		 062.4420 062.4430*	
 062.47235		 062.4153 062.4103	
 062.47245 062.47335 062.47435		 062.4154 062.4104	
 062.47255 062.47345 062.47445			
 062.47355 062.47455			



Abutment diameter

Ø 4.5 mm













Ø 6.0 mm



Ø 5.5 mm





















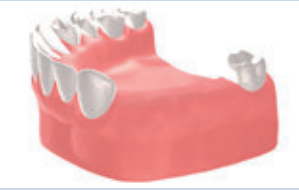

Ø 4.5 mm		Ø 6.0 mm	Ø 5.5 mm	
			 <p>062.4953</p>	
 <p>062.4722S</p>	 <p>062.4420 062.4430*</p>		 <p>062.4954</p>	 <p>062.8410</p>
 <p>062.4723S</p>		 <p>062.4153 062.4103</p>		
 <p>062.4724S 062.4733S 062.4743S</p>		 <p>062.4154 062.4104</p>		
 <p>062.4725S 062.4734S 062.4744S</p>				
 <p>062.4735S 062.4745S</p>				

3. Prosthetic portfolio overview



3.1 Prosthetic options

		BL	BLX	
<p>Single crown</p> 	Screw-retained	 Gold Abutment, for crown	●	●
		 Straumann® CARES® Ceramic Abutment	●	-
		 Straumann® CARES® CoCr & CoCr AS	●	●
		 Straumann® Variobase® Abutment	●	●
		 Straumann® Screw-retained Abutment	●	●
	Cement-retained	 Anatomic Abutment	●	●
		 Gold Abutment, for crown	●	●
		 Straumann® CARES® Ceramic Abutment	●	-
		 Straumann® Variobase® Abutment	●	●
		 Straumann® CARES® Titanium Abutment	●	●
 Cementable Abutment	●	-		
<p>Bridge</p> 	Screw-retained	 Gold Abutment, for bridge	●	●
		 Straumann® Screw-retained Abutment	●	●
	Cement-retained	 Anatomic Abutment	●	●
		 Gold Abutment, for crown	●	●
		 Straumann® CARES® Ceramic Abutment	●	-
		 Straumann® CARES® Titanium Abutment	●	●
		 Straumann® Variobase® Abutment	●	●
		 Cementable Abutment	●	-















BL BLX



			BL	BLX
Retentive Anchor		Straumann® LOCATOR®	●	-
		Straumann® Novaloc®	●	●
Bar		Straumann® Screw-retained Abutment	●	●
Customized bar		Gold Abutment, for bridge	●	●
Telescope		Anatomic Abutment	●	-
		Gold Abutment, for crown	●	●













3.2 Abutment Overview

	Anatomic Abutment	Gold Abutment, for crown	Gold Abutment, for bridge	Straumann® CARES® Ceramic Abutment	Straumann® CARES® Titanium Abutment	Straumann® CARES Abutment CoCr & CoCr AS
						
						
Single crown						
Screw-retained		•		•		•
Cement-retained	•	•		•	•	
Bridge						
Screw-retained			•			
Cement-retained	•	•	•	•	•	
Removable overdentures						
Telescope	•	•				
Retentive anchor						
Bar			•			
Impression						
Implant level	•	•	•	•	•	•
Abutment level						
Material*	Titanium	Ceramicor®	Ceramicor®	Zirconium dioxide	Titanium	Cobalt Chromium
Chapter	7.2	7.3	7.4	1)	1)	1)

*See information on sterilization conditions in chapter 9.

**ADLC: Amorphous Diamond-Like Carbon coating



Straumann® Variobase® Abutment	Cementable Abutment	Straumann® Screw-retained Abutment	LOCATOR® Abutment	Straumann® Novaloc® Abutment
				
				
•		•		
•	•			
•		•		
•	•			
			•	•
		•		
		•	•	•
	•	•	•	•
			•	
Titanium alloy	Titanium	Titanium alloy	Titanium alloy	Titanium and ADLC** coating
2)	7.5	7.6	7.9	3)

1) For further information regarding CARES® implant-borne prosthetics, please see the *Straumann® CARES® Implant-borne prosthetics, Basic Information (702165/en)*.

2) For further information regarding Variobase®, please refer to the brochure *Straumann® Variobase®, Basic Information (490.062/en)*.

3) For further information regarding Novaloc®, please refer to *Straumann® Novaloc® Retentive System for Hybrid Dentures Basic Information (490.115/en)*.

4. Preoperative planning



Careful treatment planning is of utmost importance. Comprehensive pre-implantation diagnosis, evaluation and planning are prerequisites to ensure treatment success. The implant forms the apical extension of the restoration and is thus the planning basis for the surgical procedure aiming at a specific prosthetic result. Clear communication between the patient, dentist and dental technician is imperative to achieve excellent implant-borne restorations.

4.1 Wax-up/Set-up

To determine the topographical situation, axial orientation and the appropriate implants, making a wax-up/set up using the previously prepared study cast is recommended. Subsequently, the type of superstructure can be defined.

The wax-up/set-up can later be used as the basis for a custom-made X-ray or drill template and for a temporary restoration.

Abutments should always be loaded axially. Ideally, the long axis of the implant is aligned with the cusps of the opposing tooth. Extreme cusp formation should be avoided as this can lead to unphysiological loading.

4.2 X-ray template with reference spheres

For easier determination of bone availability, the use of an X-ray template with X-ray reference spheres (Article 049.076V4) is recommended. First, mark the selected implant positions on the study cast. Then fix the X-ray reference spheres at the marked points and make the vacuum-formed template with the spheres. The subsequently taken X-ray or computer tomography (CT) gives information on bone availability, quality and mucosal thickness. Based on these properties the number of implants, the exact implant positions, diameters and lengths can be determined.



The X-ray reference sphere (Article 049.076V4) has a diameter of 5 mm. The image of the sphere on the X-ray provides the reference value for the magnification scale.

4.3 Custom-made drill template – BL/BLT only

A custom-made drill template can facilitate planning and the preparation of the implant bed and enables precise use of the cutting instruments. The basis of planning when making this surgical template should be the desired prosthetic result.

With these components, a surgical drill template can be produced in the usual manner:

Art. No.	Article	Dimensions
049.810V4		Drill sleeve with collar height 10 mm outside \varnothing 3.5 mm inside \varnothing 2.3 mm
049.818V4		Stepped pin for 049.810 height 16 mm \varnothing 2.2/3.5 mm
049.816V4		Pin for 049.810 height 16 mm, \varnothing 2.2 mm
049.817V4		Pin for 049.810 height 10 mm, \varnothing 2.2 mm
049.819V4		Pin for 049.810 height 16 mm, \varnothing 3.5 mm

For step-by-step instructions, please refer to the brochure *Fabrication and Use of an Individual Drill Template – Straumann® Drill Template* (152.290/en).

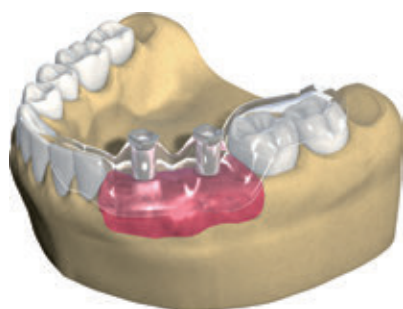

Vacuum-formed template with integrated drill sleeve as drilling template.

5. Soft tissue management



The Straumann® Bone Level Implant lines put a strong emphasis on esthetic considerations. They offer tailor-made solutions that allow for natural soft tissue shaping and maintenance in all indications. A versatile portfolio of healing and temporary abutments is available, including customizable products made of polymer for easy and fast processing.

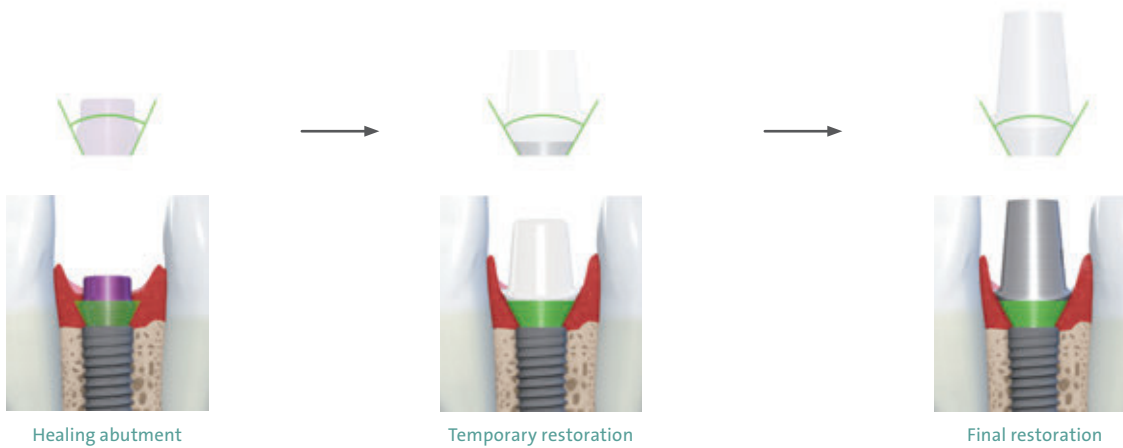

Esthetic results are determined by successful soft tissue management. To optimize the soft tissue management process, various components with Consistent Emergence Profiles™ are available in the prosthetic portfolio of the Straumann® Bone Level Implants. This applies for most healing abutments, the temporary abutment and the abutments for the final restoration. Thus, the emergence profiles are uniform throughout the treatment process (for optimal healing abutment selection see chapter 5.3).

5.1 Soft tissue management solutions

	Healing Abutment		Temporary Abutment		
	Prefabricated healing abutment (Titanium or Zirconia)	Customizable healing abutment (polymer)	PMMA with titanium alloy inlay	Titanium alloy (TAN)	Immediate temporary abutment
BL/BLT (CrossFit®)					
BLX (TorcFit™)					



5.2 Prefabricated Healing Abutment – Prosthetic procedure

Step 1 – Insertion

- Insert the healing abutment with the SCS screwdriver. The friction fit secures the healing abutment to the instrument during insertion and ensures safe handling.
- Hand-tighten the healing abutment. The cone-in-cone design provides a tight connection between the two components.

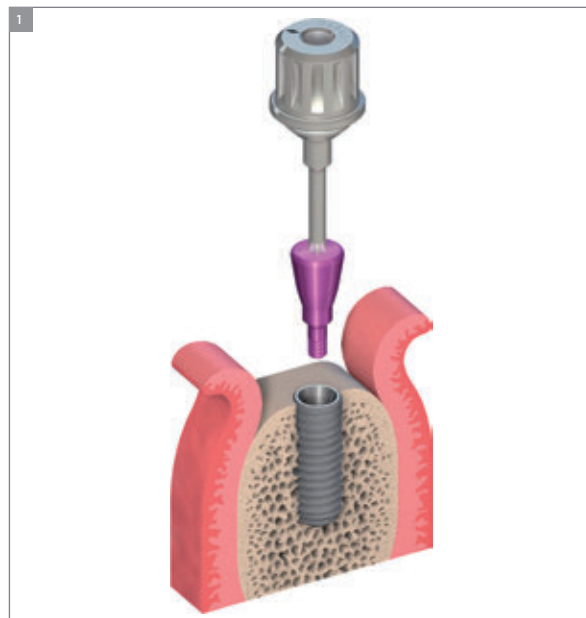

Step 2 – Wound closure

- Adapt the soft tissue and suture it back tightly around the abutment.



Optional: Bottle-shaped and Customizable Healing Abutment

The bottle-shaped healing abutment pre-shapes the soft tissue by allowing for a slight excess of mucosa during healing. The insertion of the final restoration pushes the formed tissue outward, supports the creation of a naturally shaped peri-implant soft tissue.

Note: The bottle-shaped healing abutment are only available in titanium.

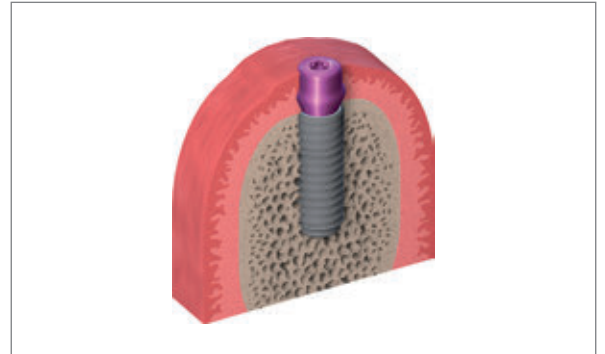



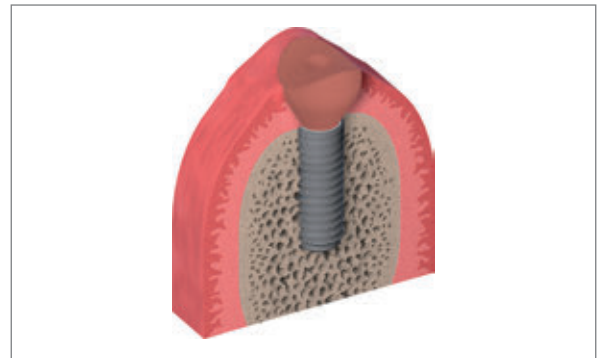





The customizable healing abutment allows for individual soft tissue management.









Note: Do not use healing components for longer than 180 days. Some healing components are provided sterile, others not and therefore have to be sterilized prior to use (refer to specific instruction for use).

5.3 Overview of suitable healing abutments for CrossFit® abutments

Cement-retained solutions

Platform	NC												
Type	Anatomic Abutment				Cementable Abutment								
													
Material	Ti		Ti		Ti				Ti				
Angle	0°		15°		0°				0°				
∅ (mm)	4.0		4.0		3.5				5.0				
GH (mm)	2.0	3.5	2.0	3.5	1.0	2.0	3.0	1.0	2.0	3.0	1.0	2.0	3.0
	3.5	5.0	3.5	5.0	3.5	3.5	5.0	2.0	3.5	5.0	2.0	3.5	5.0
∅ (mm)	4.8				4.8	3.6			4.8				
Type													
	Conical healing Abutment												









Platform	RC												
Type	Anatomic Abutment				Cementable Abutment								
													
Material	Ti		Ti		Ti				Ti				
Angle	0°		15°		0°				0°				
∅ (mm)	6.5		6.5		5.0				6.5				
GH (mm)	2.0	3.5	2.0	3.5	1.0	2.0	3.0	1.0	2.0	3.0	1.0	2.0	3.0
	4.0	6.0	4.0	6.0	2.0	4.0	6.0	2.0	4.0	6.0	2.0	4.0	6.0
∅ (mm)	6.5				5.0				6.5				
Type													
	Conical Healing Abutment												







Screw-retained solutions

Platform	NC											
Type	Screw-retained Abutment											
												
Material	TAN			TAN			TAN			TAN		
Angle	0°			0°			17°			30°		
∅ (mm)	3.5			4.6			4.6			4.6		
GH (mm)	1.0	2.5	4.0	1.0	2.5	4.0	2.5	4.0	5.5	2.5	4.0	5.5
GH (mm)	2.0	3.5	5.0	2.0	3.5	5.0	3.5			4.8		
∅ (mm)	3.6			4.8			3.5			4.8		
Type												
	Conical Healing Abutment											

Platform	RC											
Type	Screw-retained Abutment											
												
Material	TAN			TAN			TAN					
Angle	0°			17°			30°					
∅ (mm)	4.6			4.6			4.6					
GH (mm)	1.0	2.5	4.0	2.5	4.0	5.5	2.5	4.0	5.5			
GH (mm)	2.0	4.0	6.0	4.0			5.0					
∅ (mm)	5.0			4.0			5.0					
Type												
	Conical Healing Abutment											

Hybrid solutions













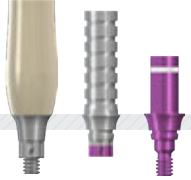

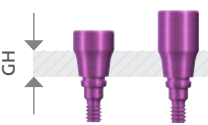
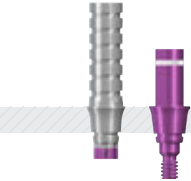



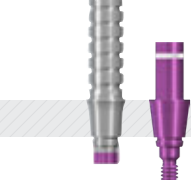

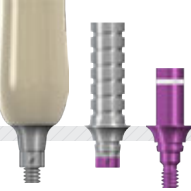

Platform	NC																
Type	Screw-retained Abutment									LOCATOR®							
Material	TAN			TAN			TAN			TAN			Ti alloy				
Angle	0°			0°			17°			30°			0°				
∅ (mm)	3.5			4.6			4.6			4.6			3.8				
GH (mm)	1.0	2.5	4.0	1.0	2.5	4.0	2.5	4.0	5.5	2.5	4.0	5.5	2.0	3.0	4.0	5.0	6.0
GH (mm)	2.0	3.5	5.0	2.0	3.5	5.0	3.5			3.5			2.0	3.5	5.0		
∅ (mm)	3.6			4.8			4.8			4.8			3.6				
Type																	
	Conical Healing Abutment																
																	



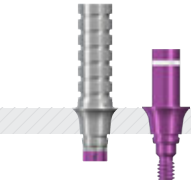



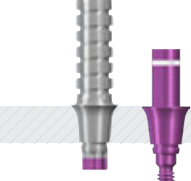





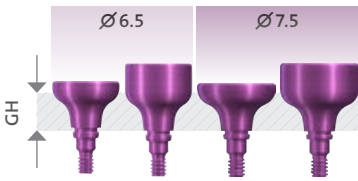

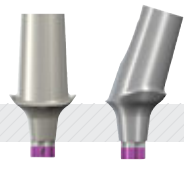



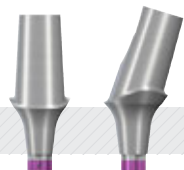

Platform	RC														
Type	Screw-retained Abutment						LOCATOR®								
Material	TAN			TAN			TAN			Ti alloy					
Angle	0°			17°			30°			0°					
∅ (mm)	4.6			4.6			4.6			3.8					
GH (mm)	1.0	2.5	4.0	2.5	4.0	5.5	2.5	4.0	5.5	1.0	2.0	3.0	4.0	5.0	6.0
GH (mm)	2.0	4.0	4.0	3.5			3.5			2.0	4.0	6.0	5.0		
∅ (mm)	5.0			5.0			5.0			5.0					
Type															
															
	Conical Healing Abutment														

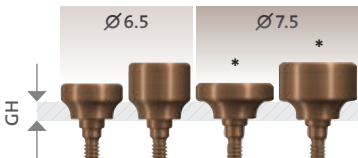
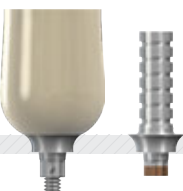
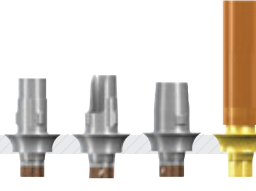

5.4 Overview of Consistent Emergence Profiles™ for TorcFit™ abutments







5.4.1 Which healing abutments suit which final abutment?

Crowns		Healing Abutments for Crown*	Temporary Abutments for Crown	Final Abutments
Final Abutment Ø3.8 mm 	Gingiva Height  GH 1.5 mm	 064.4202S / 064.4203S	 064.4361 / 064.4362 / 064.4322S	 062.4934 062.4981 062.4501 062.4410
	Gingiva Height  GH 2.5 mm	 064.4204S / 064.4205S	 064.4363 / 064.4323S	 062.4935 062.4502
	Gingiva Height  GH 3.5 mm	 064.4206S / 064.4207S	 064.4364 / 064.4324S	 062.4936 062.4503
Final Abutment Ø4.5 mm 	Gingiva Height  GH 1.5 mm	 064.4212S / 064.4213S	 064.4371 / 064.4372 / 064.4332S	 062.4944 062.4972 062.4982 062.4722S 062.4420
	Gingiva Height  GH 2.5 mm	 064.4214S / 064.4215S	 064.4373 / 064.4333S	 062.4945 062.4723S
	Gingiva Height  GH 3.5 mm	 064.4216S / 064.4217S	 064.4374 / 064.4334S	 062.4946 062.4724S

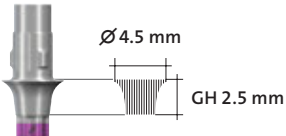
Crowns		Healing Abutments for Crown*	Temporary Abutments for Crown	Final Abutments
Final Abutment Ø6.0 mm 	Gingiva Height  GH 2.5 mm	 Ø 6.5 Ø 7.5 064.4224S / 064.4225S 064.4234S / 064.4235S	 064.4382	 062.4103 / 062.4153
	Gingiva Height  GH 3.5 mm	 Ø 6.5 Ø 7.5 064.4226S / 064.4227S 064.4236S / 064.4237S	 064.4383	 062.4104 / 062.4154
Final Abutment Ø5.5 mm 	Gingiva Height  GH 0.75 mm	 Ø 6.5 Ø 7.5 064.8201S / 064.8202S / 064.8203S / 064.8204S	 064.4391	 062.4953
	Gingiva Height  GH 1.5 mm	 Ø 6.5 Ø 7.5 064.8212S / 064.8213S / 064.8214S / 064.8215S	 064.4390 / 064.4392	 062.4954 / 062.4971 / 062.4983 / 062.8410
Bridges		Healing Abutments for Bridges	Temporary Abutments for Bridges	Final Abutments Bridges
Final Abutment Ø4.5 mm 	Gingiva Height  GH 1.5 mm	 064.4232S / 064.4233S	 064.4352	 062.4961 / 062.4430

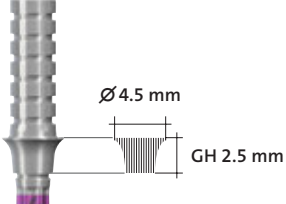
* Healing abutments with same consistent emergence profile (CEP) and different final diameter.

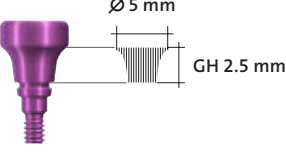
5.4.2 How to match fitting TorcFit™ components

Dimensions on components	Label	Label text
 <p>Ø 4.5 mm GH 2.5 mm</p>	 <p>EN RB/WB Variobase® for Crown incl. screw, Ø 4.5mm, GH 2.5mm, AH 5.5mm, TAN</p> <p>DE RB/WB Variobase® für Krone inkl. Schraube, Ø 4.5mm, GH 2.5mm, AH 5.5mm, TAN</p> <p>FR RB/WB Variobase® pour couronne avec vis, Ø 4.5mm, GH 2.5mm, AH 5.5mm, TAN</p> <p>IT RB/WB Variobase® per corona vite incl., Ø 4.5mm, GH 2.5mm, AH 5.5mm, TAN</p> <p>PT RB/WB Variobase® para coroa incl. parafuso, Ø 4.5mm, GH 2.5mm, AH 5.5mm, TAN</p> <p>ES RB/WB Variobase® para corona incl. tornillo, Ø 4.5mm, GH 2.5mm, AH 5.5mm, TAN</p> <p>REF 062.4943 LOT XXXXX ZZZZZZZZZ</p> <p>Institut Straumann AG • Peter Merian-Weg 12 • CH-4002 Basel • Switzerland</p>	<p>RB/WB Variobase® for Crown, incl. screw, Ø 4.5 mm, GH 2.5 mm, AH 5.5 mm, TAN</p>
 <p>Ø 4.5 mm GH 2.5 mm</p>	 <p>EN RB/WB Temporary Abutment for crown, Ø 4.5mm, GH 2.5mm, TAN</p> <p>DE RB/WB Provisoriumsekundärteil für Krone, Ø 4.5mm, GH 2.5mm, TAN</p> <p>FR RB/WB Pilier provisoire pour couronne, Ø 4.5mm, GH 2.5mm, TAN</p> <p>IT RB/WB Componente secondaria provvisoria per corona, Ø 4.5mm, GH 2.5mm, TAN</p> <p>PT RB/WB Pilar provisório para coroa, Ø 4.5mm, GH 2.5mm, TAN</p> <p>ES RB/WB Pilar provisional para corona, Ø 4.5mm, GH 2.5mm, TAN</p> <p>REF 064.4373 LOT XXXXX ZZZZZZZZZ</p> <p>Institut Straumann AG • Peter Merian-Weg 12 • CH-4002 Basel • Switzerland</p>	<p>RB/WB Temporary Abutment, for crown, Ø 4.5 mm, GH 2.5 mm, TAN</p>
 <p>Ø 5 mm GH 2.5 mm</p>	 <p>RB/WB Healing Abutment Crown, Ø 5mm, GH 2.5mm, AH 2mm, Ti</p> <p>DE RB/WB Gingivaltrommel Krone, Ø 5mm, GH 2.5mm, AH 2mm, Ti</p> <p>FR RB/WB Pilier de occlusion couronne, Ø 5mm, GH 2.5mm, AH 2mm, Ti</p> <p>IT RB/WB Componente secondaria di guarnigione corona, Ø 5mm, GH 2.5mm, AH 2mm, Ti</p> <p>PT RB/WB Pilar de oclusão coroa, Ø 5mm, GH 2.5mm, AH 2mm, Ti</p> <p>ES RB/WB Pilar de oclusión corona, Ø 5mm, GH 2.5mm, AH 2mm, Ti</p>	<p>RB/WB Healing Abutment*, Crown, Ø 5 mm, GH 2.5 mm, AH 2 mm, Ti</p>

* Healing abutments anticipate the final crown, therefore, they have a larger nominal diameter than the final abutments.



5.5 Prefabricated healing abutment

Application

- Soft tissue management
- Closure of implant connection for non-submerged healing

Characteristics

Simple

- One-piece design for titanium healing abutments
- Two-piece design behaving like a one-piece with integrated titanium screw for ceramic healing abutments
- Color-coded and laser-marked (titanium healing abutments only)
- Anatomically shaped emergence profiles, matching impression post and final abutments (for optimal healing abutment selection see chapter 5.3)

Reliable

- Tight connection

Note: Do not use for longer than 180 days.

BL/BLT (CrossFit®)



BLX (TorcFit™)



5.6 Customizable Healing Abutment

Application

- Individual soft tissue management for esthetic cases
- Closure of implant connection during healing phase

Characteristics

Simple

- Polymer material allows for easy and quick chair-side modification
- Easy-to-achieve esthetics due to gingiva-colored and modifiable polymer material

Reliable

- CrossFit® connection



Note: Do not use for longer than 180 days.

The customizable healing abutment can be shortened vertically no more than 5 mm.

5.6.1 Customizable Healing Abutment – Prosthetic procedure

Step 1 – Customizing

- Individualize the healing abutment on an analog according to the mouth situation. Heatless wheels and new cross-toothed millers are recommended for grinding.



- To avoid smearing of the polymer, adjust the bur speed properly (low rpm frequency, little pressure).



Step 2 – Insertion

- Hand-tighten the healing abutment in the implant with the SCS screwdriver and temporarily seal the screw channel (e.g. with composite).



5.7 Temporary Abutment – Polymer with titanium-alloy inlay (VITA CAD-Temp®/TAN)

Application

- Individual soft tissue management for esthetic cases
- Screw- or cement-retained temporary crowns
- Cement-retained temporary bridges

Characteristics

Simple

- Easy-to-achieve esthetic long-term temporary crowns and bridges (maximum 180 days)
- Tooth-colored customizable polymer material

Efficient

- Efficient chair-side dentist workflow: ready-to-prepare temporary abutment

Reliable

- CrossFit® and TorcFit™ connections: precise fit and high mechanical stability

Note

Do not use for longer than 180 days. Place temporary restoration out of occlusion.

- The devices are provided non-sterile and are for single use only.
- The abutment must be secured against aspiration during intral-oral use.
- The abutments must be cleaned and sterilized prior use. Follow the guidelines described in the IFU.



5.7.1 Prosthetic procedure for Temporary Abutment

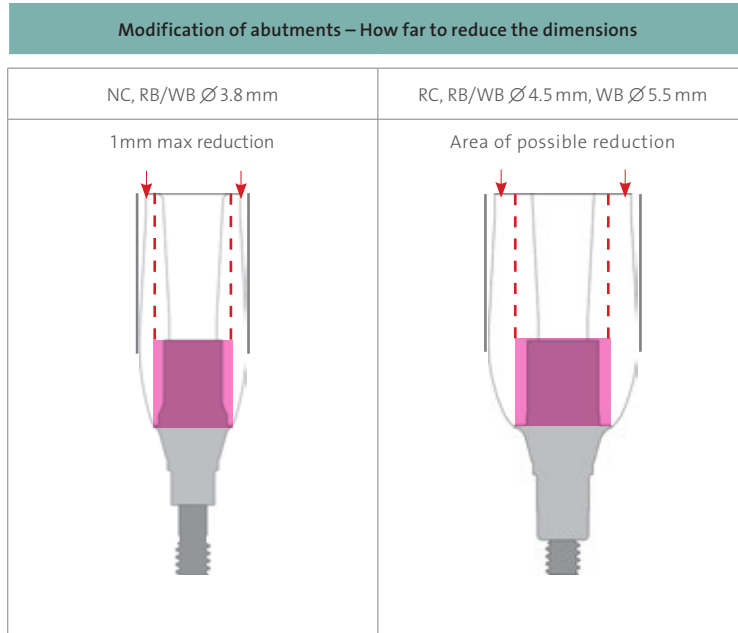

Red line indicates the area of maximum reduction

Note: Please refer to the graphics above for details on modification limits. Small-diameter VITA CAD-Temp® abutments (NC and \varnothing 3.8 mm RB/WB) should not be used in the molar region or other high-load situations due to the risk of abutment overload.

The temporary abutment height can be shortened with standard tools and techniques, but should not be reduced beyond the metal core. The width must not be reduced by more than 1 mm at the thickest part (NC, RB/WB \varnothing 3.8 mm) or further than the metal margin (RC, RB/WB \varnothing 4.5 mm, WB \varnothing 5.5 mm).

Option A: Screw-retained temporary crown

Step 1 – Individualization – Removing material

Individualize the temporary abutment on an analog according to the mouth situation. Fine-cut tungsten-carbide tools are recommended for processing this polymer material.

Insertion in master model

Hand-tighten the temporary abutment in the implant analog with the SCS screwdriver and temporarily seal the screw channel (e.g. with cotton).





Step 2 – Option A: Fabricating the temporary restoration – Direct veneering

Directly add the veneering material in order to fabricate the temporary restoration.



Step 2 – Option B: Fabricating the temporary restoration – Vacuum stents

Create the temporary restoration according to standard techniques (e.g. vacuum stents).



Note: Before adding up any material or performing corrections with veneering material (i.e. VITA VM® LC materials, refer to the manufacturer's instructions), the surface of the temporary restorations must be cleaned and wetted with modeling liquid.

Note: Clean the abutment with a steam jet.

- Lab procedure
- Prosthetic procedure



Step 3 – Finishing

Remove excess acrylic, reopen the screw channel and finish the temporary restoration.

Note: Restorations made from VITA CAD-Temp® can be pre-polished with a suitable silicone polisher and a small goat-hair brush. Standard acrylic polishing agents that are also suitable for intraoral use are used for high luster polishing.

Avoid creating excessive heat.

Important:

Careful polishing is absolutely necessary to achieve a perfect result and to avoid plaque accumulation and related negative effects on the shade. Use a polishing aid or implant analog to protect the abutment connection while polishing the temporary restoration.



Step 4 – Final insertion

Clean, disinfect and sterilize the polished temporary restoration (refer to the manufacturer's instructions of the veneering material).

Place the temporary restoration on the implant and tighten the screw with a minimum torque value of 15 Ncm, without exceeding 35 Ncm (depending on implant stability) using the SCS screwdriver along with the ratchet and the torque control device.





Option B: Cement-retained temporary crown

Step 1 – Individualization – Removing material

Individualize the temporary abutment on an analog according to the mouth situation. Fine-cut tungsten-carbide tools are recommended for processing this polymer material.



Step 2 – Fabricating the cement-retained temporary single crown

Use a standard procedure to fabricate the cement-retained single crown (e.g. grind out a prefabricated plastic tooth).





Step 3 – Final insertion

Clean, disinfect and sterilize the polished temporary abutment.

Place the customized temporary abutment on the implant and tighten the screw with a minimum torque value of 15 Ncm, without exceeding 35 Ncm (depending on implant stability) using the SCS screwdriver along with the ratchet and the torque control device.



■ Prosthetic procedure



Cover the screw head with absorbent cotton or gutta-percha and seal the screw channel temporarily (e.g. with absorbent cotton).



Step 4 – Cementing the temporary single crown

Coat the internal configuration of the crown with temporary cement and cement it on the temporary abutment.





5.8 Temporary abutment – Titanium alloy (TAN)

Application

- Engaging abutments are used for
 - Screw- or cement-retained temporary crowns
 - Cement-retained temporary bridges
- Non-engaging abutments are used for
 - Screw-retained temporary bridges

Characteristics

More solutions

- Narrow diameter for narrow interdental spaces
- Crowns and bridges
- Screw- and cement-retained
- Anterior and posterior region

Reliable

- Precise fit and high stability due to titanium alloy (TAN) material

Note: Do not use for longer than 180 days.

Place temporary restorations out of occlusion.

The temporary abutment can be shortened vertically no more than 6 mm with standard tools and procedures.

BL/BLT (CrossFit®)



BLX (TorcFit™)



- Lab procedure
- Prosthetic procedure



5.8.1 Temporary Abutment – Procedure for a screw-retained bridge temporary restoration

Step 1 – Preparation

- Mount the temporary abutment on the master cast or in patient's mouth.
- Mark the appropriate heights according to the individual situation.
- Remove the abutment from the patient's mouth.

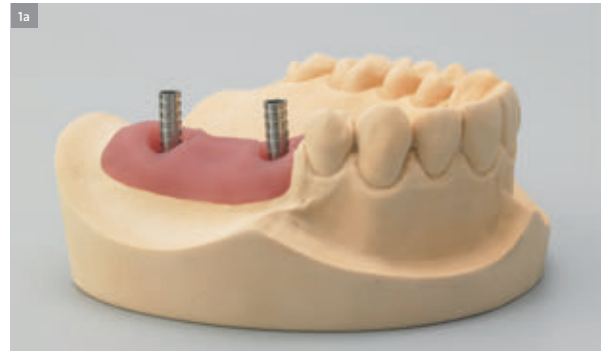

- Shorten the abutment as necessary using standard technique.
- The upper section of the abutment should be sandblasted before opaquing.
- Coat the temporary abutment with opaquer to prevent the titanium alloy (TAN) from showing through.



- Screw the abutments onto the implant in the patient's mouth and temporarily seal the screw channels (e.g. with cotton).



Note: Repeat the procedure for screw- or cement-retained crown provisional restoration by using the engaging temporary abutments. Use the SCS screwdriver 046.401 (short) or 046.402 (long). Depending on implant stability, tighten with a torque between 15 Ncm and 35 Ncm. Hand-tighten on the master cast. The abutment should not diverge more than 30° for a screw-retained bridge. Manufacture a meso structure with a cemented restoration in order to compensate divergences greater than 30°.

- Lab procedure
- Prosthetic procedure



Step 2 – Creating the provisional

- Use standard procedure to fabricate the provisional (e.g. prefabricated crown or bridge form or vacuum-formed sheet technique as shown here). The retention elements ensure proper mechanical bonding of the veneering material to the temporary abutment.
- Remove excess acrylic, reopen the screw channel and finish the temporary restoration.



Step 3 – Inserting the provisional

- Clean and disinfect the polished temporary restoration, place it on the implants and tighten the screw between 15 Ncm and 35 Ncm (depending on implant stability) using the SCS screwdriver along with the ratchet and the torque control device (for instructions see chapter 8.5).
- Cover the screw head with absorbent cotton or gutta-percha and seal the screw channel with temporary veneering material (e.g. composite).





5.9 Immediate Temporary abutment - Titanium alloy (TAN)

Application

- Cement-retained temporary crowns
- In implants that are osseointegrated or in immediate loading technique as long as the minimum implant insertion torque value of 35 Ncm has been achieved

Characteristics

Simple

- Chairside workflow using associated Plastic Coping
- Easy choice of components thanks to color-coding

Reliable

- Pre-sterilized abutment

Note: Do not keep the Immediate Temporary Abutment and Plastic Coping in the patient's mouth for longer than 180 days. The temporary cement margin shall be less than 2 mm below the gingiva.

BLX (TorcFit™)

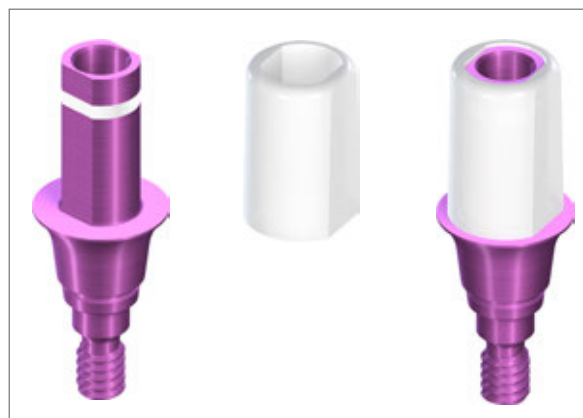

Magenta abutments: RB/WB connection

BL/BLT (CrossFit®)



Yellow abutments: NC connection











Grey abutments (natural TAN color): RC connection



5.9.1 Overview of BLX RB/WB Immediate Temporary Abutments and Plastic Coping

	Ø3.8 mm 	Ø4.5 mm 	Compatible Plastic Coping (PMMA)
Gingiva Height  GH 1.5 mm	 064.43225	 064.43325	 023.0033V2 (pack of 2)
Gingiva Height  GH 2.5 mm	 064.43235	 064.43335	
Gingiva Height  GH 3.5 mm	 064.43245	 064.43345	

5.9.2 Overview of BL/BLT NC and RC Immediate Temporary Abutments and Plastic Coping

	NC	RC	Compatible Plastic Coping (PMMA)
Gingiva Height  GH 1.0 mm	 022.01155	 022.01185	 023.0033V2 (pack of 2)
Gingiva Height  GH 2.0 mm	 022.01165	 022.01195	
Gingiva Height  GH 3.0 mm	 022.01175	 022.01205	

■ Prosthetic procedure

Step 1 – Abutment insertion

Screw the abutment into the implant and tighten it with a minimum torque value of 15 Ncm, without exceeding 35 Ncm.



Step 2 – Preparation

Use a sterile rubber dam to cover the soft tissue around the abutment during the procedure.

Caution: The Plastic Copings for Straumann Immediate Temporary Abutments are delivered non-sterile and must be cleaned and disinfected prior to use. Follow the procedure on cleaning and disinfection defined in the Instructions for Use.

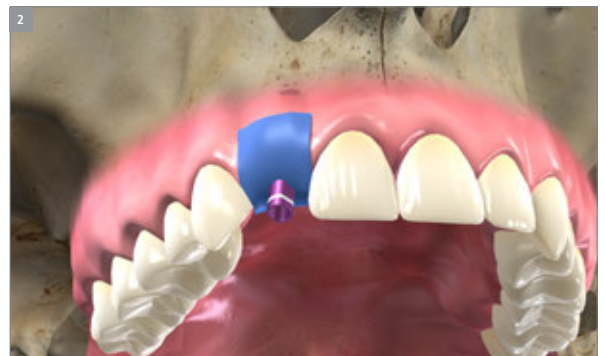

Step 3 – Customizing the abutment and coping

Customization is to be performed in the mouth of the patient or chairside in a controlled surgical environment with sterile instruments, preferably single-use sterile instruments, using aseptic technique. Mark the desired height according to the oral situation and shorten the abutment using copious irrigation. Shorten the plastic coping accordingly.

Caution:

- Do not shorten the abutment more than below the mark.
- The Immediate Temporary Abutments are intended for single unit restorations.
- The minimum post height of the abutment and coping can be reduced to 4 mm. There is to be no angular correction during customization of the coping.

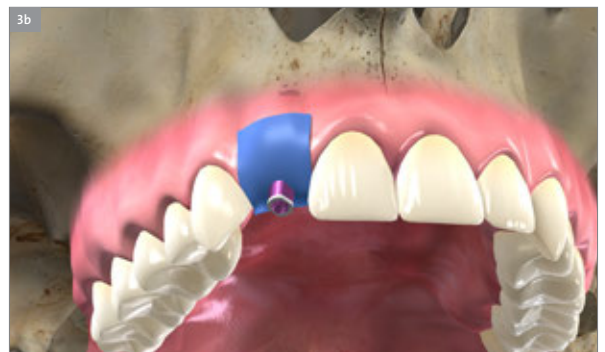
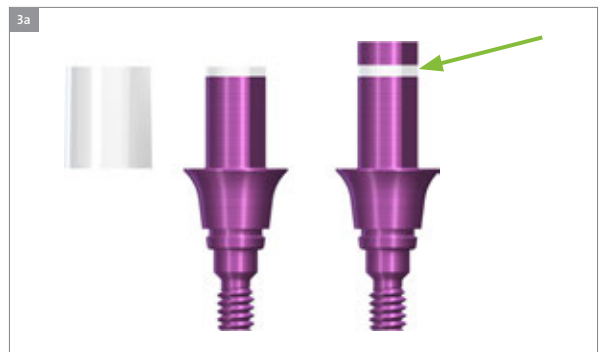

■ Prosthetic procedure

Step 4 – Creating the provisional

Place the coping onto the abutment.

Cover the top of the abutment and coping with wax to prevent acrylic from entering the abutment screw access hole and/or the cement gap.

Caution: The Plastic Copings for Straumann Immediate Temporary Abutments are delivered non-sterile and must be manually cleaned and manually disinfected prior to use. Follow the procedure on cleaning and disinfection defined in the IFU.

Fill up a temporary crown shell with acrylic.

Note: Make sure to choose acrylic material indicated for light-cure bonding to PMMA and follow the manufacturer's instructions. Adapt the quantity of acrylic material to leave space for the coping.

Place the filled crown shell onto the coping, remove excess acrylic and light cure.

Step 5 – Inserting the provisional

After finishing the crown outside the patient's mouth, fix it onto the abutment using temporary cement. Remove excess cement. Remove the rubber dam.

Warning: Any excess cement left may lead to biological complications.

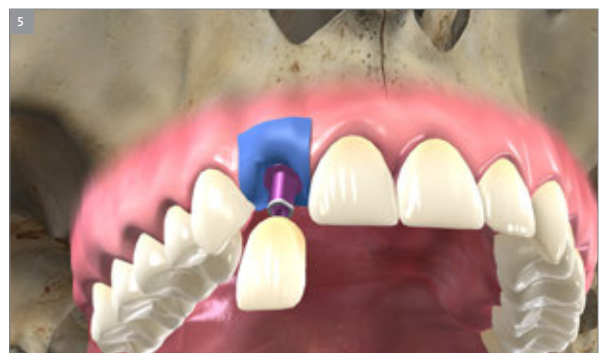

6. Impression taking



6.1 Options for impression taking

Impressions for the Straumann® Bone Level Implant can be taken by either of the two following procedures:

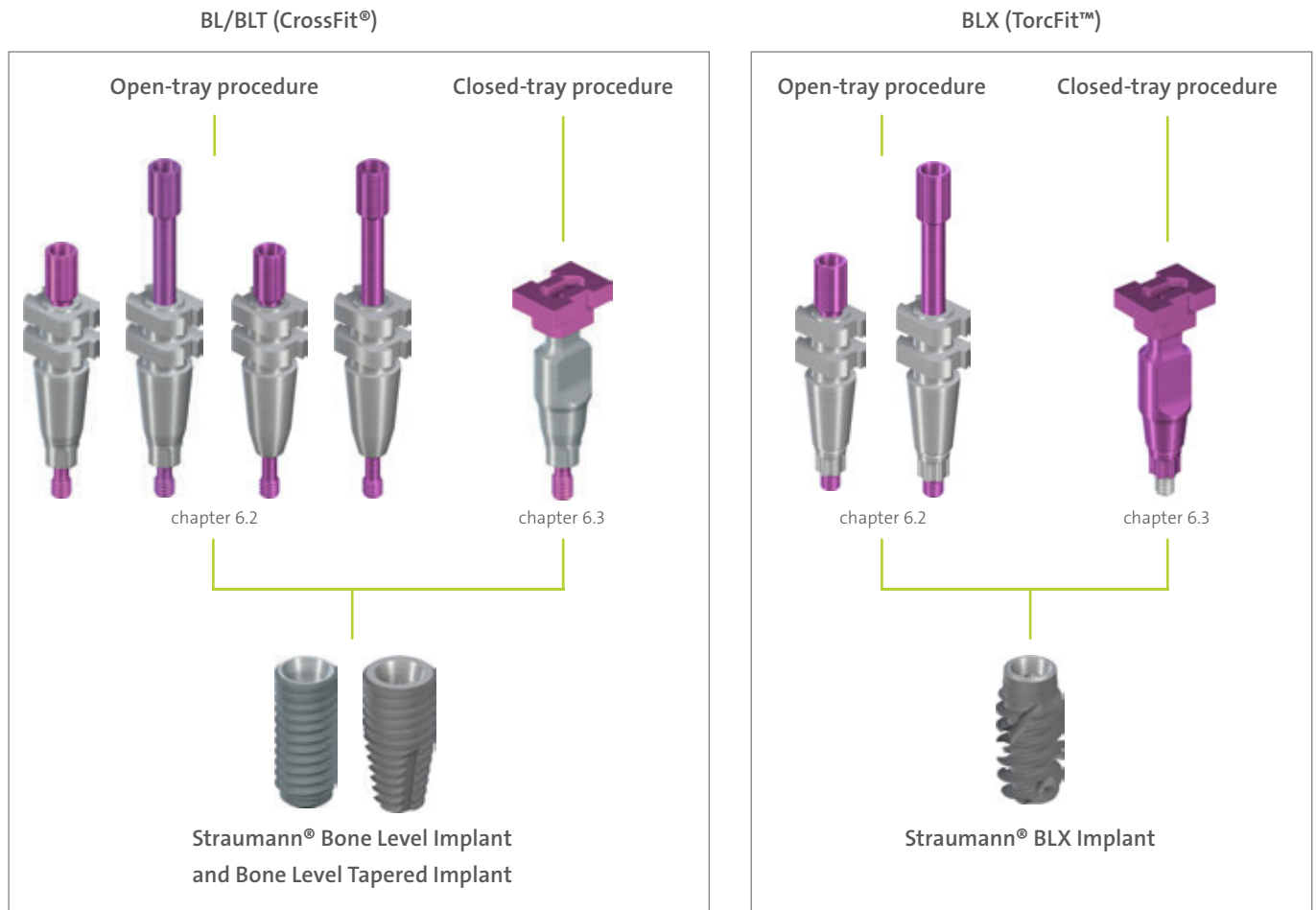

The procedure used depends on the user's preference and the clinical situation. Both procedures are described in the following chapters.

For instructions how to use the CARES® Mono Scanbody, please refer to *Step-by-step instructions on the intraoral scanbodies, Basic Information (702063/en)*.

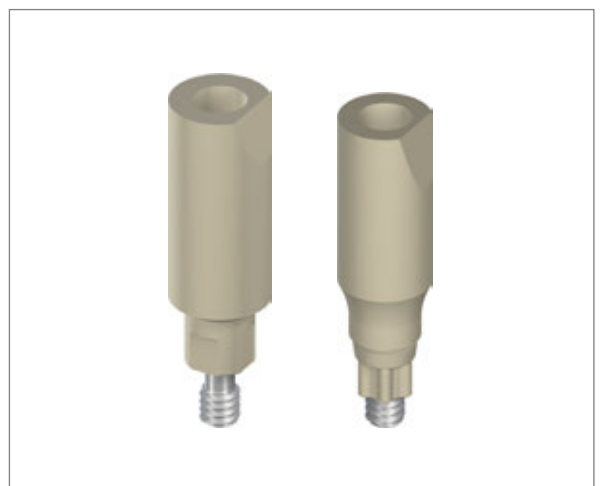



BL/BLT (CrossFit®)

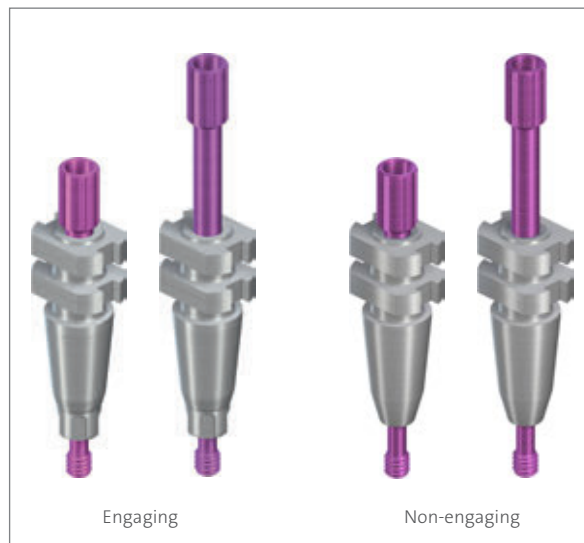

BLX (TorcFit™)



6.2 Open-tray impression

Application

- Open-tray impression procedure

Characteristics

Simple

- Slender emergence profile accommodates space limitations
- Guide screw can be tightened either by hand or with the SCS screwdriver

Reliable

- High-precision impression components give an exact replica of the intraoral situation
- Tactile response from the prosthetic connection verifies proper seating of components

Note: Open-tray impression procedure requires a custom-made tray with perforations.

Impression posts are intended for single use only to ensure optimal fit and precise impression taking for each patient.

Non-engaging impression components are to be used exclusively for bridge or full-arch restorations at implant level.



6.2.1 Open-tray impression – Prosthetic procedure

Step 1 – Positioning the impression post

- Ensure sufficient access to the implant site in order to avoid pinching in the gingival tissue. Be aware that the sulcus may collapse rapidly once the healing components have been removed.
- Clean the internal configuration of the implant thoroughly from blood, tissue, etc. prior to the impression procedure.
- Place the impression post accurately into the implant and hand-tighten the guide screw.
- In case of occlusal space limitation, the length of the impression post can be reduced by one retention ring after the guide screw has been removed.



- Lab procedure
- Prosthetic procedure



Step 2 – Impression taking

- Make perforations in the custom-made impression tray (light cured resin) according to the individual situation so that the positioning screw of the impression post sticks out.



- Take the impression using an elastomeric impression material (polyvinyl siloxane or polyether rubber).



Note: Due to its low tensile strength, hydrocolloid is not suitable for this application.

- Uncover the screws before the material is cured.
- Once the material is cured, loosen the guide screws and remove the tray.

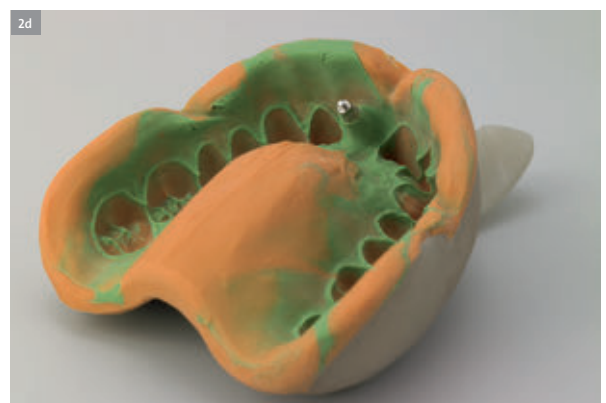



6.2.2 Open-tray impression – Lab procedure

Step 1 – Analog repositioning and fixing

- Reposition and fix the analog in the impression using the guide screw. To avoid inaccuracies when connecting, the analog must be positioned exactly in line with the grooves of the impression post before screwing in.

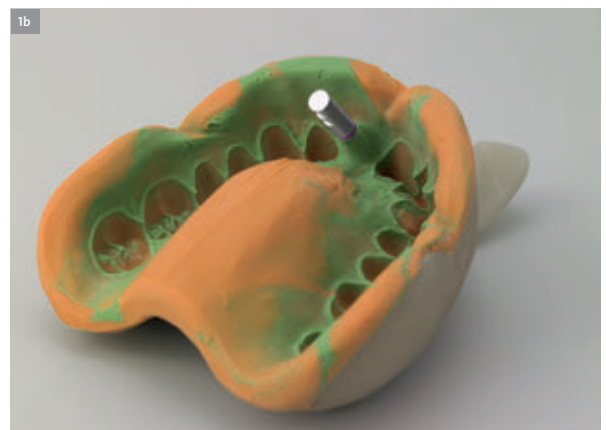
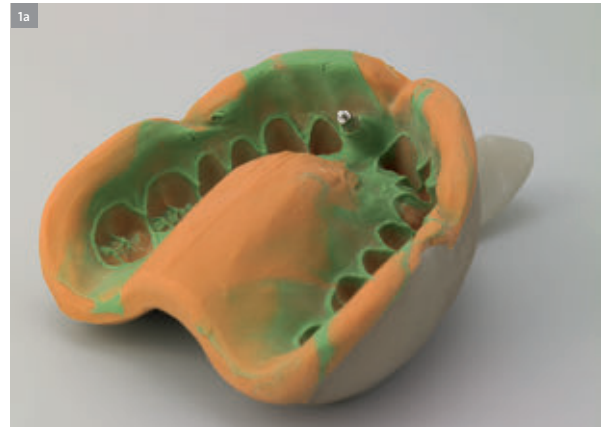

Note: When tightening the screw, grasp the retentive section of the analog securely to prevent the impression post from rotating. This is especially important with a shortened post.

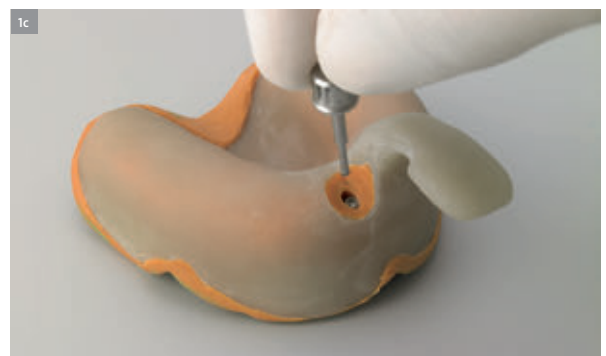

Step 2 – Fabricating the master cast

- Fabricate the master cast using standard procedure and type-4 dental stone (ISO 6873). A gingival mask should always be used to ensure that the emergence profile of the crown is optimally contoured.





BL/BLT (CrossFit®)

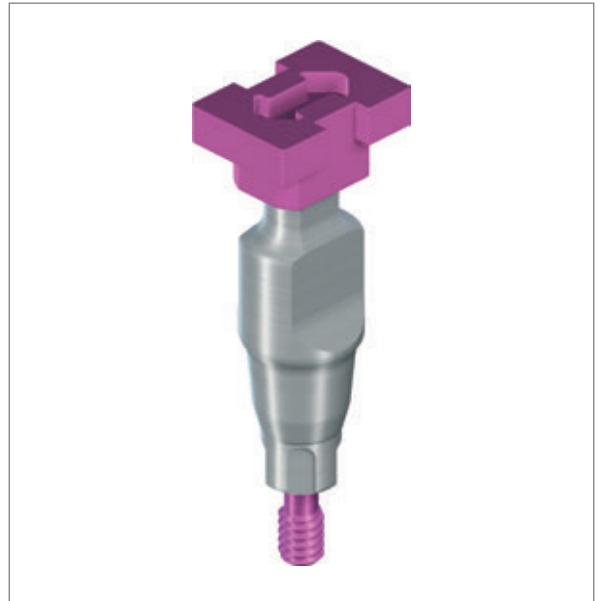

6.3 Closed-tray impression

Application

- Closed-tray impression procedure

Characteristics

Simple

- Slender emergence profile to accommodate space limitations
- No additional preparation (i.e. perforation) of tray required

Reliable

- High-precision impression components give an exact replica of the intraoral situation
- Tactile response from the prosthetic connection verifies proper seating of components

Note: Impression posts are intended for single use only to ensure optimal fit and precise impression taking for each patient. A spare cap is provided with each package in case there is a need to retake the impression immediately.

BLX (TorcFit™)

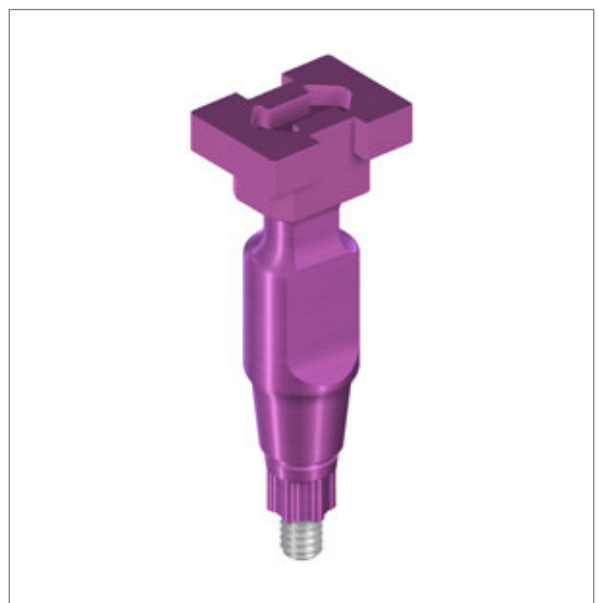



6.3.1 Closed-tray impression – Prosthetic procedure

Step 1 – Positioning the impression post

- Ensure sufficient access to the implant site in order to avoid pinching in the gingival tissue. Be aware that the sulcus may collapse rapidly once the healing components have been removed.
- Clean the internal configuration of the implant thoroughly from blood, tissue, etc. prior to the impression procedure.
- Place the impression post accurately into the implant ensuring that the lateral planar areas of the post are facing mesial and distal. Tighten the guide screw hand-tight (using the SCS screwdriver).



- Place the polymer impression cap on top of the fixed impression post. Ensure that the color of the cap corresponds to the color of the positioning screw in the post and that the arrows are aligned with the oral-vestibular direction.
- Push the impression cap in apical direction until it clicks. The impression cap is now firmly seated on the impression post.





Step 2 – Impression taking

- Take the impression using an elastomeric impression material (polyvinyl siloxane or polyether rubber).

Note: Due to its low tensile strength, hydrocolloid is not suitable for this application.



- Once the material is cured, carefully remove the tray. The impression cap remains in the impression material and therefore is automatically pulled off from the impression post with the removal of the tray from the patient's mouth.



- Unscrew and remove the impression post and send it together with the impression tray to the dental technician.

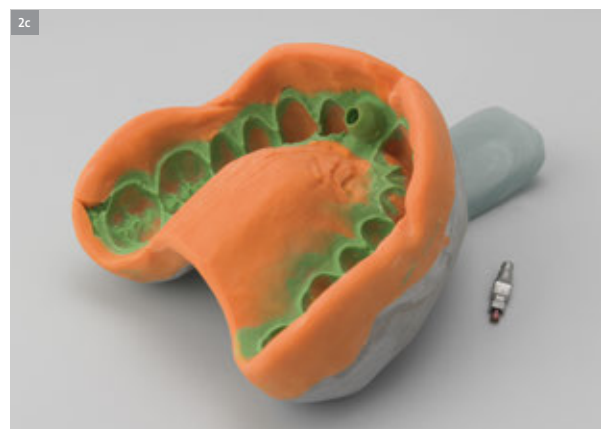



6.3.2 Closed-tray impression – Lab procedure

Step 1 – Analog fixing and impression post repositioning

- Mount the impression post on the analog using the guide screw. To avoid inaccuracies when connecting, the analog must be positioned exactly in line with the grooves of the impression post before screwing it in.



Note: Ensure that the color code of the guide screw corresponds to the color code of the analog and that the color code of the analog corresponds to the color code of the polymer cap in the impression material.

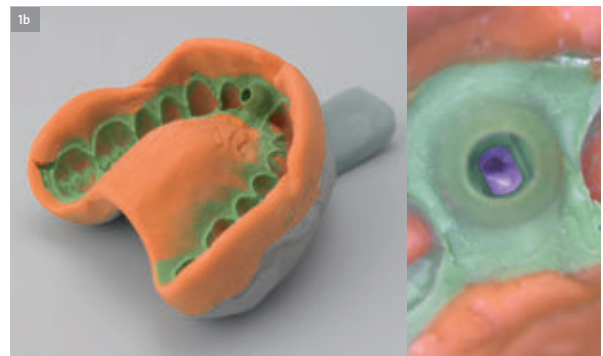

- Reposition the impression post in the tray.
- Smoothly push the impression post until you feel the tactile response of engagement. It is now firmly seated on the impression cap in the impression tray.

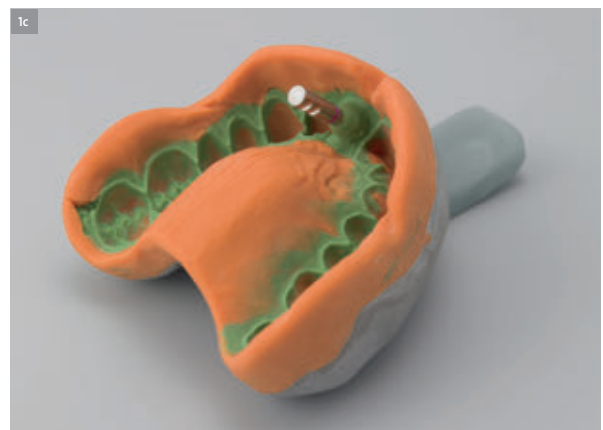

Step 2 – Fabricating the master cast

- Fabricate the master cast using standard procedure and a type-4 dental stone (ISO 6873). A gingiva mask should always be used to ensure that the emergence profile of the crown is optimally contoured.



6.4 Bite registration

To simplify bite registration after impression taking, plastic bite registration aids are available in various heights. For repositioning on the master cast, the bite registration aids have a flat side laterally.

Step 1 – Insertion

- Insert the bite registration aids into the implants. Each component is fitted with a snap mechanism that holds it in the internal configuration.

Note: Protect the components against aspiration (e.g. use a throat pack or a thread).



Step 2 – Shortening

- Shorten the bite registration aids (if needed) and apply the bite registration material. To ensure the repositioning from the mouth to the master cast, the occlusal area and the lateral flat side of the bite registration aids must be adequately surrounded with the registration material.

Note: Bite registration aids must be shaped out of the mouth. If they need to be shortened occlusally due to lack of space, ensure that the lateral flat side is not ground off.

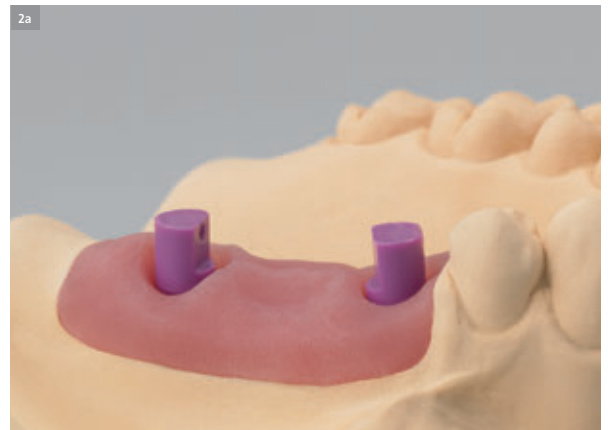

Step 3 – Positioning

- To transfer the bite, put the bite registration in the analogs on the master cast. Fix the bite wax model and mount the maxilla and mandible casts on the articulator.



7. Restoration



7.1 CrossFit® Plan Set/Plan abutment

Application

- Intra- and extra-oral planning of prosthetic restoration

Characteristics

Simple

- Color-coded, well-marked and easily readable Plan abutments
- Comprehensive Plan set containing all Plan abutments arranged clearly
- Easy handling with the SCS screwdriver

Reliable

- Proper seating of Plan abutments verified through the tactile response from the prosthetic connection
- Plan abutments fabricated of sterilizable polymer material



Note:

- Prior to intraoral use the Plan abutments must be processed.
- Follow the procedures defined in the Instructions for Use.
- Do not sterilize the cassette or its components.
- Replace non-functional Plan abutments.

- Lab procedure: page 58
- Prosthetic procedure: pages 58-59

- Lab procedure
- Prosthetic procedure



7.1.2 CrossFit® Plan Set/Plan abutment selection

The Straumann® CrossFit® Plan Set allows for optimal planning of the restoration in the mouth and on the model. It gives the dentist and the dental technician greatest flexibility in cooperative planning and minimizes the quantity of stock abutments. The Plan set contains all Plan abutments available for the Straumann® Bone Level Implant (anatomic, cementable, screw-retained, gold, Variobase®, Novaloc® [compatible with LOCATOR®]).

Step 1 – Selecting the right abutment

- Open the Plan set cassette, pick up a Plan abutment and secure it with the SCS screwdriver (empty mold for instruments built in).

- Place the Plan abutment on the implant (intra-oral use) or implant analog (extra-oral use). This will aid in checking dimensions (rings on Plan abutments indicate gingiva height), axial alignment and screw axis of the potential restoration.



Step 2 – Ordering the stock abutment

- Once the best fitting Plan abutment is determined, order the corresponding stock abutment (titanium, gold) using the allocation chart on the Plan set inlay card.



7.1.3 Cleaning and sterilizing Plan abutments

- Clean and disinfect the Plan abutments according to *Straumann Care and maintenance* brochure.
- Sterilize Plan abutments with moist heat (autoclave), according to *Straumann Care and maintenance* brochure prior to intra-oral use.

Note:

- Do not sterilize Plan abutments more than 20 times.
- Do not gamma-sterilize Plan abutments.
- Do not sterilize the cassette or its components.



7.2 TorcFit™ Plan abutment

Characteristics

Simple

- Color-coded and easily readable
- Easy handling with the integrated holding pin
- All gingiva heights marked on each abutment

Reliable

- Plan abutments fabricated of sterilizable polymer material

Designed to facilitate Pro Arch restoration planning

- 0°, 17° and 30° abutments to cover implant divergences
- Indication of occlusal screw channel direction
- Possibility to cut the pin for easier placement in posterior region of the mouth

Notes:

- After intraoral use clean, disinfect, and sterilize the Plan abutments as described in the IFU *Instructions for use: Straumann® prosthetic planning and placement tools (702879)*
- Replace non-functional Plan abutments.
- If you decide to cut the pin, it is recommended to polish the end. Do not cut the pin shorter than the last groove.
- For extra-oral use: while these plan abutments were optimized for intra oral use, slight vertical movements are possible when used extra-orally (in implant analog). Make sure the plan abutments are correctly seated.

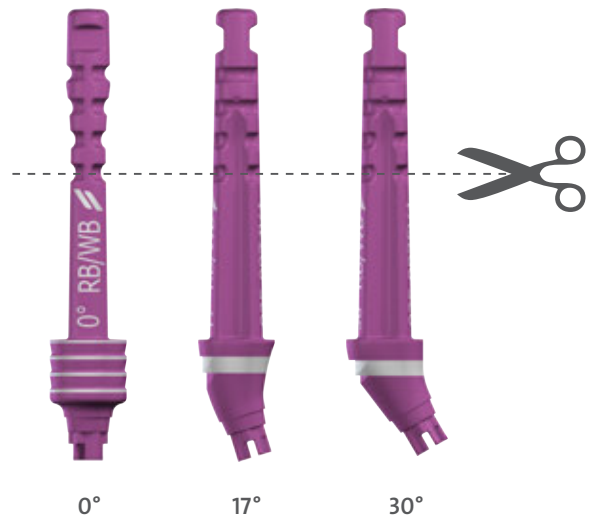

7.2.1 For single-unit restorations

Place the Plan abutment on the implant (intra-oral use) or implant analog (extra-oral use).

This will aid in checking dimensions (laser marks on Plan abutments indicate gingiva height), axial alignment and occlusal screw axis of the potential restoration.



7.2.2 For multiple-unit restorations

Place the Plan abutments on the implants (intra-oral use) or implant analog (extra-oral use).

This will aid in checking dimensions (laser marks on Plan abutments indicate gingiva height), axial alignment and occlusal screw axis of the potential restoration.

A clear duplicate of the provisional may be used to check the alignment of the different occlusal screw axis.

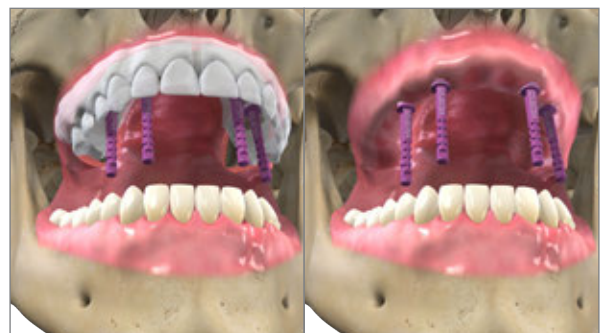



7.3 Anatomic Abutment

Application

- Cement-retained restorations

Characteristics

Simple

- Less grinding necessary due to prepared mucosa margins
- Adaptation to natural soft tissue contour due to prepared mucosa margins in different heights
- Oval shape resembles emergence profile of a natural tooth

Reliable

- CrossFit® and TorcFit™ connection

Note: Not suitable for direct ceramic veneering.

A minimum height of 3 mm above the mucosa margin of the abutment must be maintained in order to maintain proper stability of the abutment.

The cement margin must not be more than 2 mm below the mucosa. Use a new basal screw for the final insertion of the abutment.

BL/BLT (CrossFit®)



BLX (TorcFit™)



- Lab procedure: pages 61-64
- Prosthetic procedure: page 65



7.3.1 Anatomic (and Meso) Abutment – Lab procedure

The following case describes the fabrication of a cement-retained single crown by using the anatomic abutment.

Step 1 – Fabricating the master cast and wax-up

- Fabricate the master cast including a gingiva mask with the corresponding implant analog (for instructions see chapter 6).



- For optimal esthetic planning, model a full anatomical wax-up.



- Make a silicone key over the full wax-up in order to define the optimal shape of the customized abutment.





Step 2 – Preparing the Anatomic Abutment

- The anatomic abutment and the meso abutment (see following page) are made of titanium and can be modified as required.

Note: To maintain proper stability of the abutment, a minimum height of 3 mm above the mucosa margin of the abutment must be maintained.



- The anatomic abutment after modification.



Step 3 – Fabricating the superstructure

Fabricate the superstructure on the modified abutment using the standard modelling, casting and veneering methods.

- Place the modified abutment on the polishing aid/analog and hand-tighten the screw using the SCS screwdriver.
- Wax an individual resin cap onto the abutment.
- Contour a wax model according to the anatomical circumstances of the individual cast.
- Check the wax-up with the silicone key.





Step 4 – Casting and veneering

- Cast the framework using the standard procedure.

- Check the framework with the silicone key before veneering.



- Veneer the superstructure.





7.3.2 Anatomic Abutment – Prosthetic procedure

The final restoration is delivered to the doctor's office on the master cast.

Step 1 – Preparation

- Remove the healing cap or temporary restoration from the implant in the patient's mouth.
- Remove the superstructure from the master cast and unscrew the abutment from the analog.
- Clean and dry the interior of the implant and the abutment thoroughly.



Step 2 – Final insertion

- Position the cleaned abutment in the implant. Tighten the screw to 35 Ncm using the SCS screwdriver along with the ratchet and the torque control device (for instructions see chapter 8.5).
- Close the SCS configuration of the screw with cotton and sealing compound (e.g. gutta-percha). This allows a later removal of the customized abutment in case a crown replacement is required.
- Cement the superstructure to the abutment.
- Remove superfluous cement.

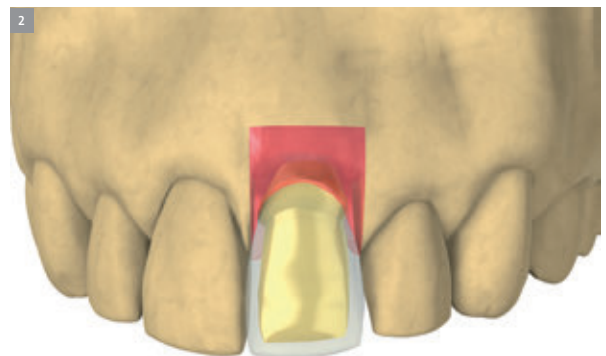



7.4 Gold Abutment for crown

Application

- Screw-retained or cement-retained crowns
- Cement-retained bridges via mesostructure (custom abutment technique)
- Telescopic crowns and telescopic bridges

Characteristics

Simple

- Easy wax-up and protection of the screw channel due to modelling aid (burn-out polymer)
- Easy-to-achieve esthetics due to individual contouring of the emergence profile and adaptation to the margin of the gingival contour

Reliable

- Superfluous cement easily removable by raising the cement margin using an individually designed mesostructure
- CrossFit® connection

Note: Not suitable for direct splinting with other gold abutments. For screw-retained bridges the gold abutment for bridge must be used (for instructions see chapter 7.4).

Use a new basal screw for the final insertion of the abutment.

Do not shorten the gold abutment for crown by more than 1.5 mm.

- Lab procedure: pages 67-76
- Prosthetic procedure: page 77

BL/BLT (CrossFit®)



BLX (TorcFit™)





7.4.1 Gold Abutment for crown – Lab procedure

The following case describes the fabrication of a cement-retained single crown by utilizing the custom abutment technique.

Step 1 – Fabricating the master cast and wax-up

- Fabricate the master cast including a gingiva mask with the corresponding implant analog (for instructions see chapter 6).



- For optimal esthetic planning, model a full anatomical wax-up.



- Make a silicone key over the full wax-up in order to define the optimal shape of the customized abutment.





Step 2 – Preparing the Gold Abutment

- Place the gold abutment on the analog and hand-tighten the screw using the SCS screwdriver.



- Shorten the modelling aid to the height of the occlusal plane according to the individual circumstances. Working with the modelling aid ensures a clean and sharp-edged finish of the screw channel.



- Attach the gold abutment to the polishing aid for easier handling during manipulation outside of the model.



Step 3 – Wax modelling

- Contour a wax-up shape according to the individual anatomical situation. The silicone key shows the exact space for the cement-retained crown, which will be made over the customized abutment.



- Make sure that the wax layer on the abutment is sufficiently thick (at least 0.7 mm). Do not cover the delicate margin of the abutment with wax.



- Check the wax-up with the silicone key.

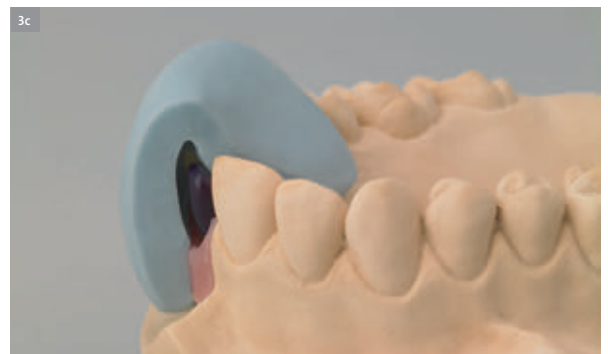

Note: The picture displays the optimal configuration of a customized abutment, showing an ideal emergence profile. This configuration ideally adapts the crown contours to the margin of the gingival contour. For reasons of hygiene, the cement margin must not lie any further than 2 mm below the gingival level.

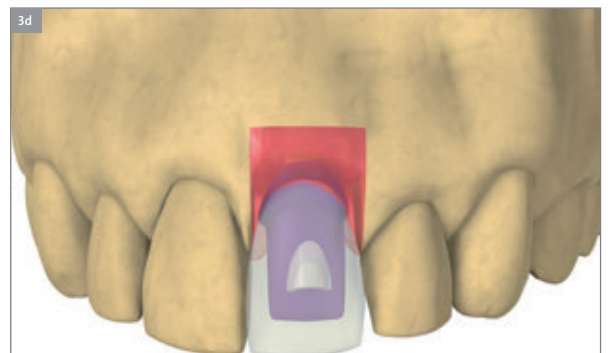



Step 4 – Investment

- Invest the customized abutment according to standard procedure without using wetting agents.

Note: In order to avoid overflow of the cast-on alloy, thoroughly clean the abutment prior to investment (removal of wax particles, insulating agents with a cotton pellet or brush moistened with alcohol).

Always do the cast with the modelling aid. Otherwise, the dental casting alloy will not or only too thinly flow out at the upper coping rim.

Ensure that there is no wax on the delicate margin. The use of investment materials for rapid heating methods (speed investment materials) is not recommended.

When processing the investment material, follow the manufacturers' instructions. Observe the recommended mixing ratio and preheating time exactly.





Step 5 – Casting and devestment

- Cast the customized abutment.
- Gently deinvest the customized abutment with ultrasound, water jet, pickling acid or a glass fiber brush.

Note: For the deinvestment of the gold abutment with sandblasting (maximum pressure: 2 bars; maximum alumina particle size: 50 μm), the inner configuration has to be protected from infiltration with sand with the polishing aid.

- The wax-fixed polishing aid allows better fixation and protects the pre-polished part of the gold abutment.





- The gold abutment after sandblasting.



Note: Do not sandblast the inner configuration of the gold abutment.





Step 6 – Polishing

- After trimming, polish the finished customized abutment.



- The customized abutment is now ready for the fabrication of the cement-retained single crown.

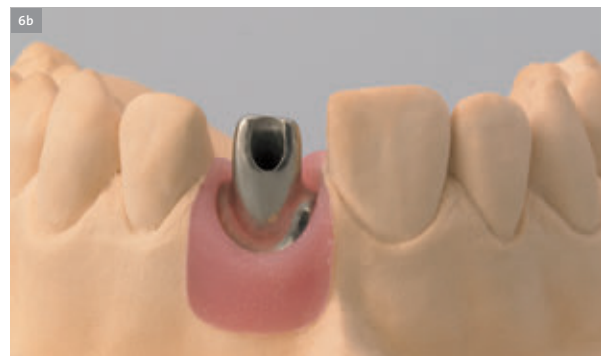

Step 7 – Fabricating the cement-retained single crown

- Block out the screw channel and wax the framework directly over the customized abutment.

- The silicone key shows the spatial relations for the restoration.



■ Lab procedure



- Cast the framework in the conventional manner. After trimming the cast, the metal crown fits precisely on the customized abutment.

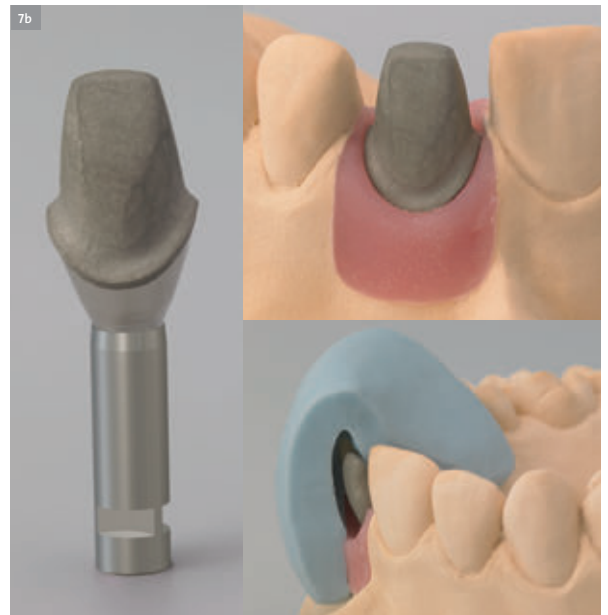

- The silicone key shows the spatial relations for veneering.

- Veneer the superstructure.





Casting errors and incorrect handling

Note: The long-term success of the prosthetic work depends on the accurate fit of the restoration.

The entire procedure has to be repeated if...

- ... trimming through the cast-on alloy prohibits the Ceramicor® surface from being covered with ceramic veneering material (Ceramicor® is a non-oxidizing alloy and does not allow ceramic bonding).

- ... the cast-on gold did not flow out entirely.

- ... intruded casting metals and casting pearls cannot be removed from the connection part of the gold abutment.





Using alloys with castable Ceramicor® components

Ceramicor® is only suitable for cast-on procedures

Ceramics can not be bonded directly to cast-on Ceramicor® components as this alloy does not form bonding oxides.

When selecting the casting alloy, ensure that it is compatible with the high-fusing alloy of the Ceramicor® components. The melting range of the casting alloy must not exceed a liquidus temperature of 1350 °C/2462 °F.

Ceramicor® must not be cast on with base metal casting alloys, because gold in combination with nickel or cobalt destroys the components.

Suitable dental casting alloys

- High noble alloys
- Precious metal alloys with a minimum content of gold and platinum group metals of 25%
- Palladium-based alloys with a minimum content of palladium of 50%

ISO standard alloy types

Alloy types according to the following ISO standards are suitable for cast-on procedures to the prefabricated Ceramicor® component:

- ISO standard 9693
- ISO standard 22674

Note: The alloy manufacturer's recommendation must be followed. Due to diffusion at the alloy and the cast-on coping interface, components made from an unsuitable alloy may form phases with low-strength, reduced corrosion resistance or a lower melting range.



7.4.2 Gold Abutment for crown – Prosthetic procedure

The final restoration is delivered to the doctor's office on the master cast.

Step 1 – Preparation

- Remove the healing cap or temporary restoration from the implant in the patient's mouth.
- Remove the superstructure from the master cast and unscrew the abutment from the analog.
- Clean and dry the interior of the implant and the abutment thoroughly.



Step 2 – Final insertion

Option A: Screw-retained crown

- Position the cleaned abutment in the implant. Tighten the screw to 35 Ncm using the SCS screwdriver along with the ratchet and the torque control device (for instructions see chapter 8.5).
- Close the SCS configuration of the screw with cotton and sealing compound (e.g. gutta-percha or composite). This allows later removal of the customized abutment in case a crown replacement is required.

Option B: Cement-retained crown

- Position the cleaned abutment in the implant. Tighten the screw to 35 Ncm using the SCS screwdriver along with the ratchet and the torque control device (for instructions see chapter 8.5).
- Close the SCS configuration of the screw with cotton and sealing compound (e.g. gutta-percha or composite). This allows later removal of the customized abutment in case a crown replacement is required.
- Cement the crown to the mesostructure.
- Remove superfluous cement.

Note: The figure displays the optimal configuration of a customized abutment, showing an ideal emergence profile. This configuration ideally adapts the crown contours to the margin of the gingival contour. For reasons of hygiene, the cement margin must not lie any further than 2 mm below the gingival level.

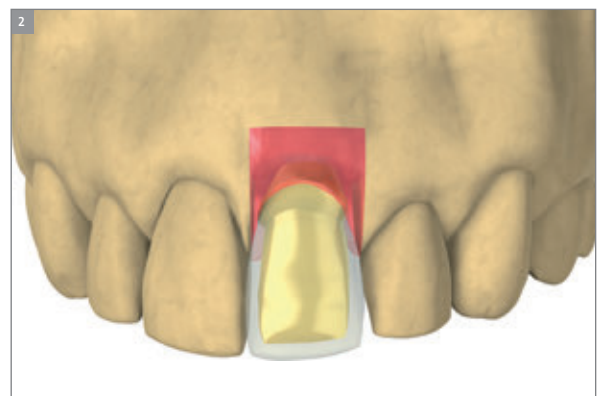



7.5 Gold abutment for bridge

Application

- Screw-retained bridges
- Screw-retained customized bars

Characteristics

Simple

- Easy wax-up and protection of the screw channel due to modelling aid (burn-out polymer)
- Easy-to-achieve esthetics due to individual contouring of the emergence profile and adaptation to the margin of the gingival contour

Reliable

- No cement gap
- One-screw solution

Note: Not suitable for single crowns. Use the gold abutment for crown for single crowns (for instructions see chapter 7.3).

Use a new basal screw for the final insertion of the abutment.

Do not shorten the gold abutment for bridge by more than 2.5 mm.

BL/BLT (CrossFit®)



BLX (TorcFit™)



- Lab procedure: pages 79-86
- Prosthetic procedure: page 87



7.5.1 Gold abutment for bridge – Lab procedure

The following case describes the planning of a screw-retained bridge.

Step 1 – Fabricating the master cast and wax-up

- Fabricate a master cast including a gingiva mask with the corresponding analogs (for instructions see chapter 6).



- For optimal esthetic planning, model a full anatomical wax-up.



- Make a silicone key over the full anatomical wax-up in order to define the optimal shape of the customized bridge.





Step 2 – Preparing the gold abutments

- Place the gold abutments for bridge on the analogs and hand-tighten the screws using the SCS screwdriver.
- Shorten the modelling aids to the height of the occlusal plane according to individual circumstances. Working with the modelling aid ensures a clean and sharp-edged finish of the screw channel.
- To avoid a deformation of the conical design of the connection it is highly recommended to always attach the gold abutment to the polishing aid while working outside of the model.

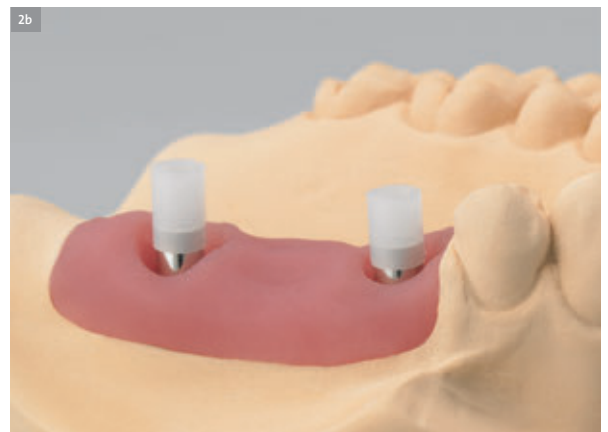



Step 3 – Wax modelling

- Contour a wax-up shape according to the individual anatomical situation.
- Make sure that the wax layer on the abutment is sufficiently thick (at least 0.7 mm). Do not cover the delicate margin of the abutments with wax.



- Check the spatial conditions before casting the bridge framework with the silicone key of the wax-up.





Step 4 – Investment

- Check that the wax framework of the bridge is absolutely tension-free before investing the framework. Use standard investing procedures for a tension-free framework.
- Invest the bridge framework according to standard methods without using wetting agents.

Note: In order to avoid overflow of the cast-on alloy, thoroughly clean the abutments prior to investment (removal of wax particles, insulating agents with a cotton pellet or brush moistened with alcohol).

Ensure that there is no wax on the delicate margin. The use of investment materials for rapid heating methods (speed investment materials) is not recommended.

When processing the investment material, follow the manufacturer's instructions. Strictly observe the recommended mixing ratio and preheating time.





Step 5 – Casting and devestment

- Cast the bridge framework.

Note: The long-term success of the prosthetic work depends on the accurate fit of the restoration. The entire procedure will have to be repeated, if casting errors occur, similar to the examples on page 75.

- Allow for enough cooling time of the casted bridge before the devestment.
- Gently deinvest the bridge framework with ultrasound, water jet, pickling acid or a glass fiber brush.

For the deinvestment of the gold abutments with sandblasting (maximum pressure: 2 bars; maximum alumina particle size: 50 μm), the inner configuration has to be protected from infiltration from sand with the polishing aid.

- The wax-fixed polishing aid allows better fixation and protects the pre-polished part of the gold abutments.





Note: To help ensure success of the restoration, a perfect prosthetic fit in the internal connection of the implant is mandatory. Take particular care not to let the bridge reconstruction fall down onto any surface. Due to the weight of the bridge construction, this might have a negative impact on the high-precision connection of the gold abutment. If the construction falls down at anytime, repeat the entire procedure.



- Do not sandblast the inner configuration of the gold abutment.

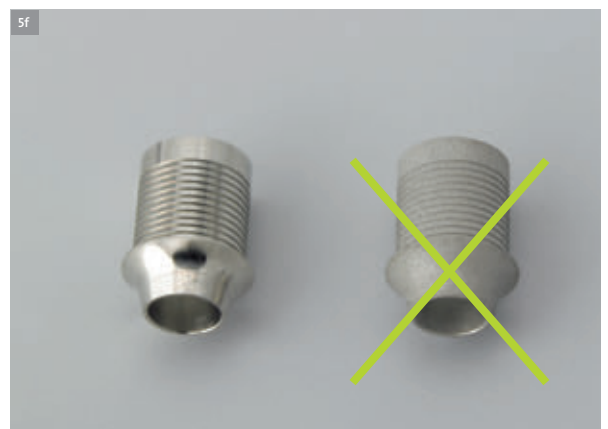



Step 6 – Preparation before veneering

- Remove the sprues and smooth the removal areas.
- Check the spatial conditions with the silicone key.



- Control tension-free fitting on the master cast (Sheffield test). If the bridge is not tension-free and therefore wiggles, cut the bridge and resplint it in a tension-free manner.

Note: In order to take the bridge off the master cast, all basal screws need to be removed first.



■ Lab procedure



- Do an additional try-on of the tension-free fit of the framework in the mouth of the patient.



Step 7 – Veneering

- Veneer the superstructure.





7.5.2 Gold abutment for bridge – Prosthetic procedure

The final restoration is delivered to the doctor's office on the master cast.

Step 1 – Preparation

- Remove the healing abutment or temporary restoration.
- Remove the superstructure from the master cast and unscrew the bridge from the analogs.
- Clean and dry the interior of the implants and the bridgework thoroughly.
- Check the tension-free fit of the bridgework before tightening it in the mouth of the patient.

Note: Do not insert the bridge in case of movements due to tensions in the bridgework.



Step 2 – Final insertion

- Position the cleaned bridgework in the implants.
- Tighten the screws to 35 Ncm using the SCS screwdriver along with the ratchet and the torque control device (for instructions see chapter 8.5).
- Close the SCS configuration of the screws with cotton and sealing compound (e.g. gutta-percha or composite). This allows later removal of the bridge work if needed.



Straumann® CARES® Implant-borne prosthetics

Straumann® CARES® CAD/CAM offers you a range of implant-borne prosthetic solutions in order to achieve high-quality dental implant restorations. Straumann® CARES® implant-borne elements are designed for high reliability and predictability.

All implant-borne prosthetic solutions can be ordered via Straumann® CARES® Visual software. Straumann® CARES® Abutments can also be ordered via the Straumann® CARES® Scan & Shape service.

Straumann® CARES® Abutments

For customized patient solutions

- For cement-retained crowns and bridges via mesostructure
- For screw-retained crowns (ceramic abutments only)
- Available in two different materials: titanium and ceramic

• Characteristics

- Customized shape and emergence profile
- Control over cement gap
- Proven Straumann precision fit



Straumann® CARES® Screw-retained bridges and bars

For complex customized patient solutions

- For screw-retained bridges
- For bars (Dolder®, MP-Clip®, Ackermann®, round)
- In two different materials: titanium Grade 4 and cobalt-chromium alloy (coron®)

• Characteristics

- Direct connection to the implant, no additional abutment needed
- High precision

For further information regarding Straumann® CARES® Implant-borne prosthetics, please refer to the brochure *Straumann® CARES® Implant-borne prosthetics, Basic Information (702165/en)*.

7.6 Cementable abutment

Application

- Cement-retained crowns and bridges

Characteristics

Simple

- Flexible impression taking on implant or abutment level
- Easy handling of prefabricated copings
- Reduce adjustment work (e.g. height adjustment)
- Easy choice of components thanks to color-coding

Reliable





- CrossFit® connection
- Perfect fit due to prefabricated components
- Proper fit of abutment level impression cap verified by tactile response

Note: Cement margin must be no more than 2 mm below the gingiva. A minimum height of 3 mm above the mucosa margin of the abutment must be maintained to ensure proper stability and retention of the restoration.

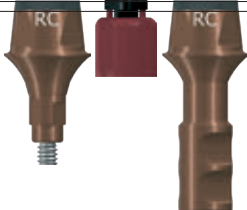

- Lab procedure: pages 97-100 and 102
- Prosthetic procedure: pages 91-96, 101 and 103

7.6.1 Cementable abutment coding

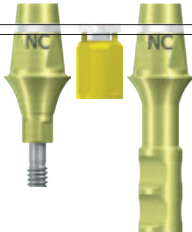
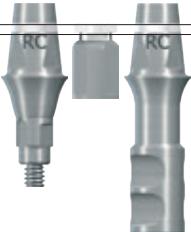
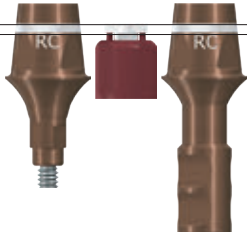
	Narrow CrossFit®		Regular CrossFit®	
Diameter (D)	3.5 mm (blue coding)	5 mm (yellow coding)	5 mm (grey coding)	6.5 mm (brown coding)
AH 4 mm (black marking)				
AH 5.5 mm (white marking)				

D = Diameter AH = Abutment Height GH = Gingiva Height

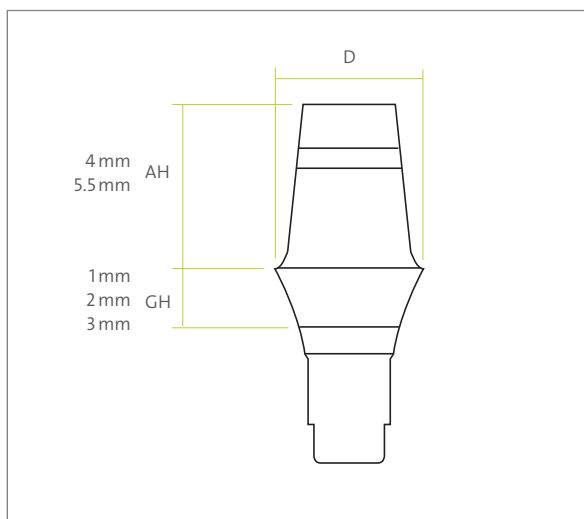

7.6.2 Conventional casting and pressing workflow

Option A: Impression taking on abutment level – Prosthetic procedure

Step 1 – Abutment insertion

- Select the appropriate size of the cementable abutment using the Plan set (for instructions see chapter 7.1).



- Thoroughly clean and dry the interior of the implant.
- Position the abutment in the implant. Tighten the screw to 35 Ncm using the SCS screwdriver along with the ratchet and the torque control device (for instructions see chapter 8.5).



Step 2 – Impression-taking on abutment level

- Click the impression cap onto the abutment.
- The white ring on the abutment indicates the abutment height (AH). It corresponds to the white arrow on top of the impression cap and the white clicking mechanism inside of the impression cap.
- Take the impression using an elastomeric impression material (polyvinyl siloxane or polyether rubber).

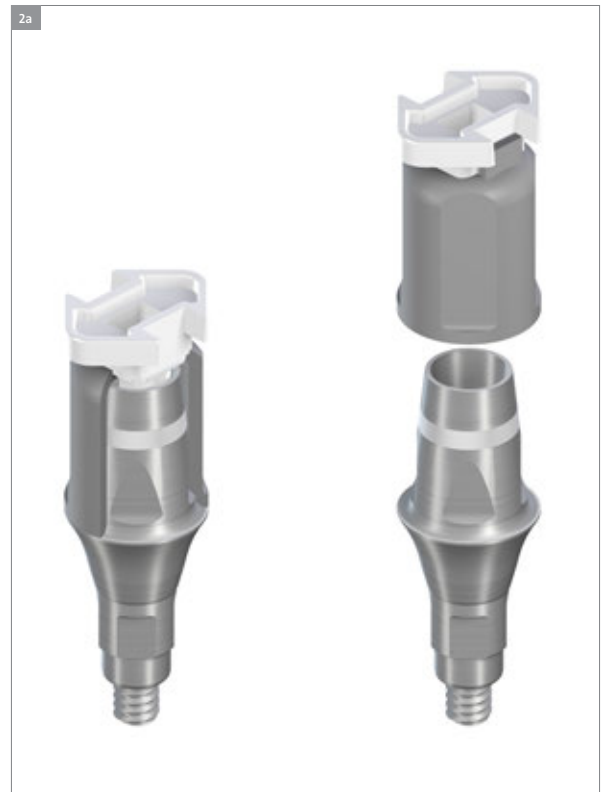

Note: Due to its low tensile strength, hydrocolloid materials are not suitable for this application.

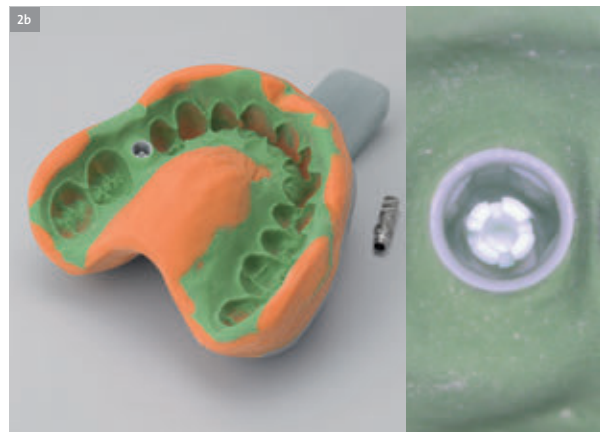

Step 3 – Customizing the abutment

- Make height adjustments according to the individual situation. This can be done down to the bottom of the black/white ring.



Chairside temporization of the abutment

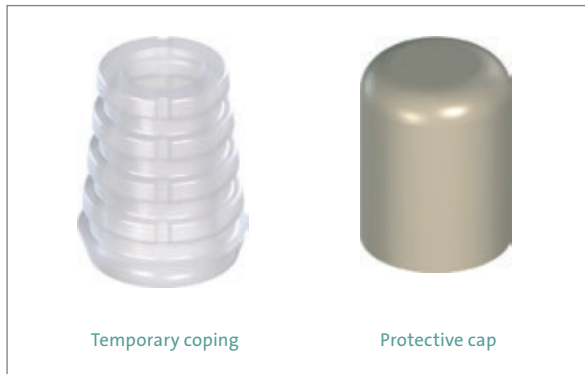

Using the temporary coping*

* For using the protective cap please refer to step 7, page 96.

Step 4 – Preparation

- Snap the temporary coping onto the abutment in the mouth of the patient.



- Mark the appropriate height according to the individual situation and shorten the coping as necessary.
- If you intend to provisionalize a bridge, remove the rotational feature of the temporary coping.

Note: Do not use Vaseline (aliphatic isolation agent) for insulation of the abutment.

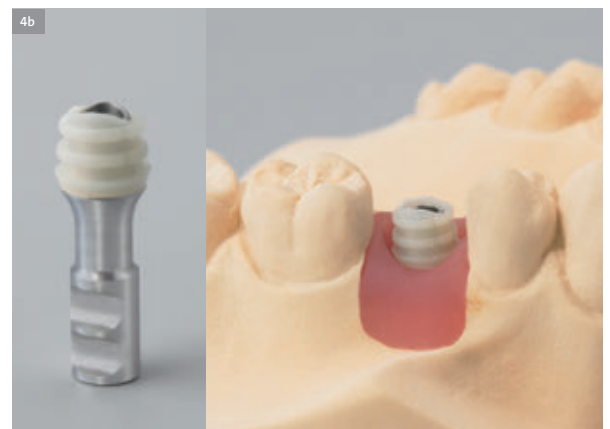

Step 5 – Creating the provisional

- Use a standard procedure to fabricate the provisional (e.g. prefabricated crown form or vacuum-formed sheet technique). The retention rings ensure proper mechanical bonding of the veneering material to the coping. The plateau of the coping helps to prevent the veneering material from flowing under the abutment.



- After the polymerization is completed, take the provisional out of the mouth and place it on the analog.



- Grind down and polish the emergence profile of the coping and the restoration to achieve an even profile. To avoid tissue irritation, the interface needs to be smooth and flush with the restoration.



Step 6 – Inserting the provisional

- Close the SCS configuration of the screw with cotton and sealing compound (e.g. gutta-percha). This allows a later removal of the provisional.
- Apply temporary cement to the inner part of the coping and cement it onto the abutment.

Note: Keep the temporary restoration out of occlusion.
Use temporary cement in order to remove the temporary restoration in due time.
Do not keep the temporary copings in the patient's mouth for longer than 180 days.



Using the protective cap

Step 7 – Cementing the protective cap

- Close the SCS configuration of the screw with cotton and sealing compound (e.g. gutta-percha). This allows a later removal of the provisional.
- Apply temporary cement to the inner part of the protective cap and cement it onto the abutment.

Note: Use temporary cement in order to remove the temporary restoration in due time.
Do not keep the protective caps in the patient's mouth for longer than 180 days.



Lab procedure

Step 1 – Fabricating the master cast

- Click the corresponding analog in the impression.

Note: Ensure that the color code of the analog corresponds to the color code of the impression cap.

The white ring on the abutment indicates the abutment height (AH). It corresponds to the white arrow on top of the impression cap and the white clicking mechanism inside of the impression cap.

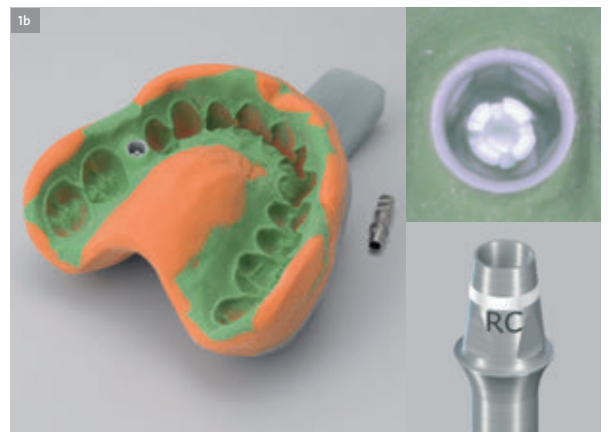
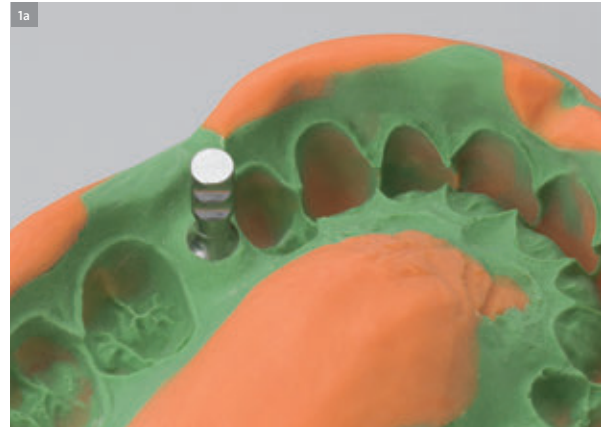

Step 2 – Preparation

- Fabricate the master cast using standard procedure (for instructions see chapter 6).
- Model a full anatomical wax-up for optimal esthetic planning. Use the corresponding burn-out coping as a basis for this wax-up.
- Make a silicone key over the full wax-up in order to define the optimal shape of the restoration.

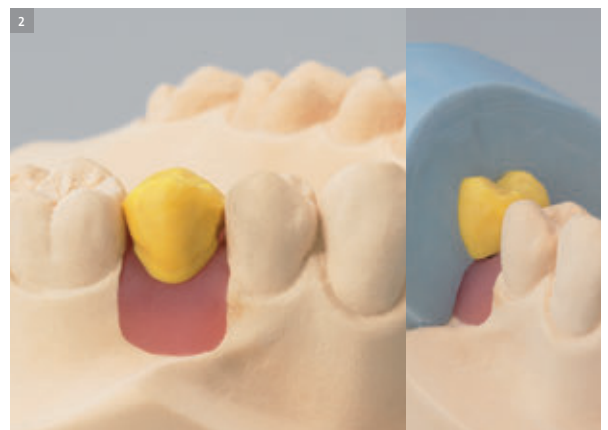

Step 3 – Customizing

- Depending on the individual situation, height adaptations can be made without harming the anti-rotational grooves.
- Individualize the abutment portion of the analog according to the individual situation.
- Fabricate a grinding template for the practitioner. This will enable the precise transfer of the individualization into the mouth of the patient.



Note: To ensure proper stability and retention of the restoration, a minimum height of 3 mm above the mucosa margin of the abutment must be maintained.

Step 4 – Fabricating the crown

- Select the burn-out coping and place it on the analog.



- Shorten the burn-out coping if necessary.



- Fabricate the superstructure on the (modified) abutment using standard modeling methods.



- Check the wax-up with the silicone key.

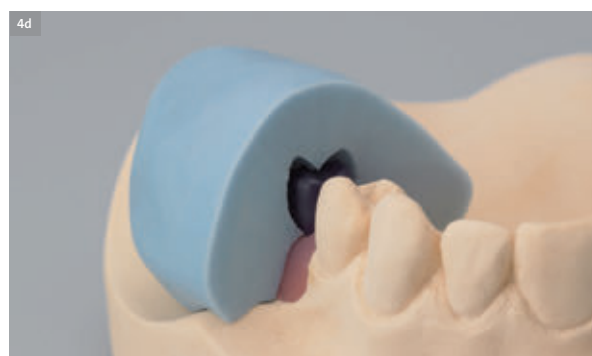

Step 5 – Casting and veneering

- Cast the framework using standard procedures.
- Adjust the framework so that it can be attached to the analog. Remove the clamping ring using a circular motion. Do not harm the rotational faces nor the exact margin fit.



- Check the spatial conditions with the silicone key.

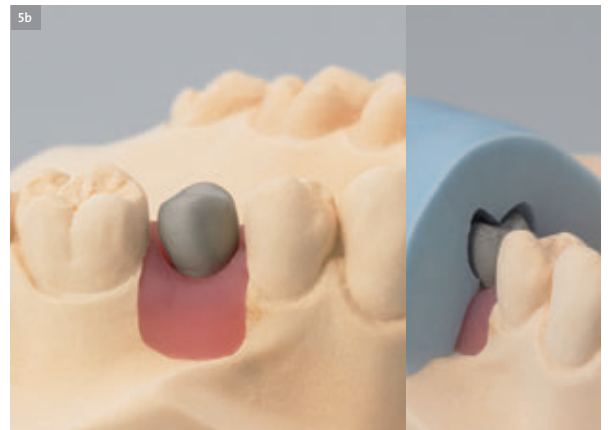

- Veneer the superstructure.



Prosthetic procedure

The final restoration is delivered to the doctor's office on the master cast.

Step 1 – Final insertion

- Remove the temporary restoration using standard procedure.
- If necessary, do the required customization of the abutment by using the reduction coping from the dental technician.
- Clean the abutment thoroughly and remove all remaining temporary cement.
- Cement the crown to the abutment.
- Remove superfluous cement.



Option B: Impression taking on implant level

Take the impression according to the instructions in chapter 6.

Lab procedure

Step 1 – Abutment insertion

- Select the correct size of the cementable abutment by using the Plan set (for instructions see chapter 7.1).
- Hand-tighten the abutment on the analog in the master cast.

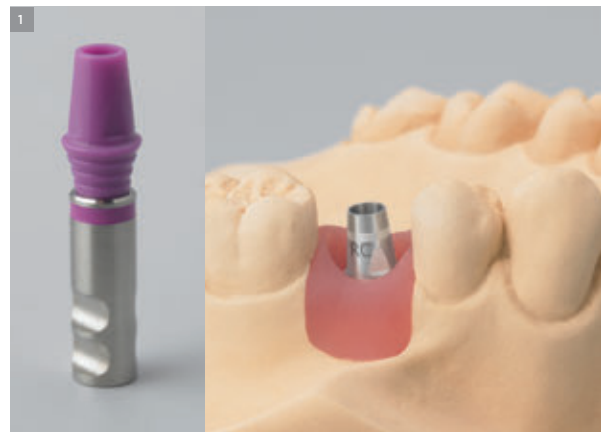

Step 2 – Customizing

- Make height adaptations according to the individual situation without harming the anti-rotational grooves.

Note: To ensure proper stability and retention of the restoration, a minimum height of 3 mm above the mucosa margin of the abutment must be maintained.

Follow the corresponding steps as described for the impression on abutment level (page 92).

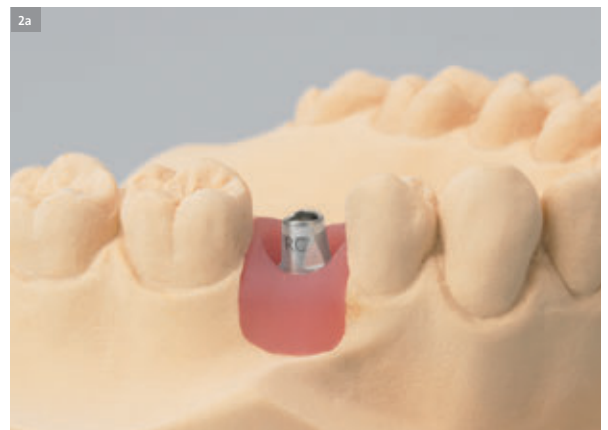

- Apply the transfer aid and attach it to the adjacent teeth.
- Deliver the customized abutment with the attached transfer aid and the final restoration to the doctor's office for insertion.



Prosthetic procedure

The final restoration is delivered to the doctor's office on the master cast.

Step 1 – Final insertion

- Position the cleaned abutment in the implant. Tighten the screw to 35 Ncm using the SCS screwdriver along with the ratchet and the torque control device (for instructions see chapter 8.5).
- Insert the abutment together with the transfer aid for a better orientation.
- Close the SCS configuration of the screw with cotton and sealing compound (e.g. gutta-percha). This later allows removal of the abutment.
- Cement the crown to the abutment.
- Remove superfluous cement.



7.6.3 Digital workflow (CAD/CAM)

Step 1 – Scanning and designing with a scanbody

Import the Straumann® Cementable Abutment Implant Kit into the design software according to the software manufacturer's instructions.



A) Assembling

Check proper fit of the scanbody in the analog and hand-tighten the self-retaining screw (maximum 15Ncm). Only use the Straumann® SCS Screwdriver to fix the post in the analog. Check again proper fit and for any rotational or vertical looseness. If a single-tooth restoration is planned, orient the angled surface of the scanbody vestibular (not adjacent to the approximal tooth). Avoid any contact of the scanbody to the proximal teeth.

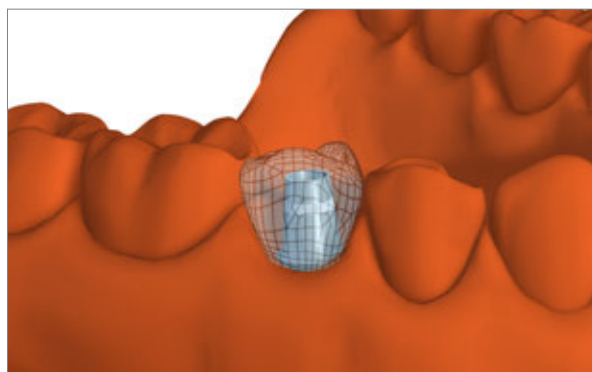

B) Scanning

Follow the Straumann® CARES® Visual CAD software provider's instructions on how to scan and recognize the scanbody.

Note: Bridges exceeding 8° angulation between implants may not fit onto the abutments.

C) Modelling

Model the framework or the full-contour restoration following the software provider's instructions.

Step 2 – Milling



Option A – Send design to Straumann milling center

Transfer your design data to Straumann via CARES® X-Stream™ and receive all prosthetic components in one delivery (e.g. abutment and its relevant superstructure).

Option B – Milling

Mill the prosthetic restoration according to the proper settings per material and following the instructions of your CAD software and milling equipment provider.

Step 3 – Finalization of the prosthetic restoration in the dental laboratory



Finalization of the prosthetic restoration

Use standard procedure to finalize the prosthetic restoration.

Send finalized restoration and abutment to the dentist for final fitting and bonding in the patient's mouth.

Note:

- The superstructure must be completely finalized before the bonding step.
- For the fitting of bridges, some adjustments of the margin of the crown over the BL abutment may be required. Make a fit-check and necessary initial adjustments on a stone model.
- Having a thicker margin around the abutment, allows for more fitting compensation.

Step 4 – Final insertion

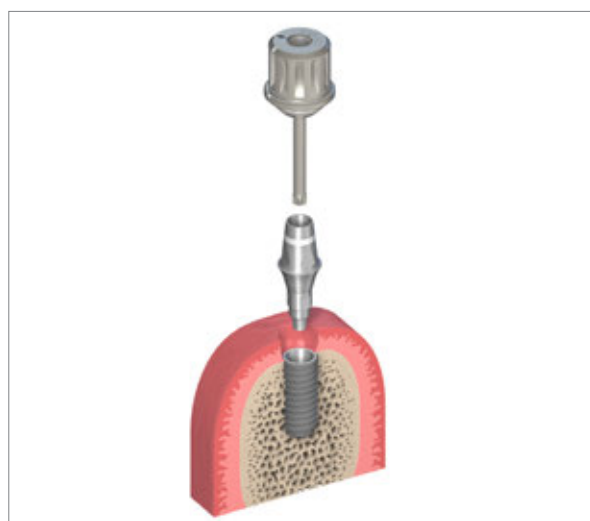

A) Fitting the final crown restoration

The restoration is delivered to the dentist with the original abutment. Place the abutment in the patient's mouth.

B) Bonding

The abutment screw is tightened with the SCS Screwdriver along with the Ratchet (046.119) and Torque Control Device (046.049).

A tightening torque of 35 Ncm is recommended for inserting the abutments.

Cement the superstructure to the abutment.

Remove excess cement.

Note:

- Due to the symmetrical nature of the Cementable Abutments, confirm the orientation of the crown according to the actual patient anatomy prior to bonding.
- The abutment must be properly positioned in the implant before the screw is tightened.
- The occlusal opening must be sealed with cotton and sealing compound (i.e. gutta-percha).





7.7 Straumann® Screw-retained Abutments

Application

- Screw-retained multi-unit as well as single-unit restorations on abutment-level
- Full-arch restorations on abutment-level, screw-retained as well as removable

Sleek design and clear portfolio

- Same low abutment connector design for all diameters allows a streamlined portfolio of tertiary components
- Abutment angulations of 17° and 30°
- Abutment design allows multi-unit as well as single-unit restorations
- Sterile packed for immediate use
- Large variety of gingiva heights available

BLX (TorcFit™)



BL/BLT (CrossFit®)



CrossFit®:

Two types of Screw-retained abutments are available, type A and type B. This enables the axis to be corrected in 8 different alignments (in 45° graduations).

Type A

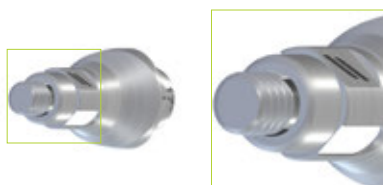

Angle between flat sides

Type B

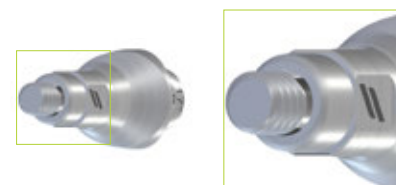

Angle to the flat wall

		Single-unit restoration	Multi-unit restorations (incisor to premolar region)	Multi-unit restorations (molar region)
NC Ø3.5 mm straight abutments	GH 1.5/2.5/3.5 mm	Yes	Yes	No
NC Ø4.6 mm straight abutments				
NC Ø4.6 mm angled abutments				
RC Ø4.6 mm straight abutments	GH 1.5/2.5/3.5 mm	No limitation		
RC Ø4.6 mm angled abutments				
RB/WB Ø4.6 mm straight abutments				
RB/WB Ø4.6 mm angled abutments	GH 3.5/4.5/5.5 mm			

*GH 2.5 not available for 30° angled abutments



Straumann® Screw-retained abutment – Color coding

	Narrow CrossFit®			Regular CrossFit®		TorcFit™ RB & WB	
Diameter	3.5	4.6		4.6		4.6	
Angulation	0°	0°	17° 30°	0°	17° 30°	0°	17° 30°
Coding	Blue	Yellow		Grey		Magenta	
Abutment height	1.8 mm	1.8 mm		1.8 mm		1.8 mm	
Angle of Abutment-restoration connection	22°	22°		22°		22°	
Gingiva heights	1mm 2.5mm 3.5mm	1mm 2.5mm 3.5mm	2.5mm 3.5mm 4.5mm 5.5mm	1.5mm 2.5mm 3.5mm	2.5mm 3.5mm 4.5mm 5.5mm	1.5mm 2.5mm 3.5mm 4.5mm	3.5mm 4.5mm 5.5mm
Impression components*							
	*impression components are available as non-engaging (for bridges and full arch restorations) and engaging components (for crowns)						
			Non engaging		Engaging		
Abutment screws	Straight	Straight abutments	Angled abutments		Straight abutments	Angled abutments	
Tightening force abutment screw	35 Ncm						
Occlusal screw							
Tightening force occlusal screw	15 Ncm						
Lab processing screws							
Lab polishing aid							
Analogs and repositionable analogs							



Ø 3.5 mm							
<p>Engaging (Crown)</p>							
	Burn-out Coping 023.2748	Temporary TAN coping 024.0021	Titanium Coping 023.2747	Gold Coping 023.2751			
<p>Non-engaging (Bridges / Bars)</p>							
	Burn-out Coping, Bridge 023.2755	Temporary TAN Coping, Bridge 024.0022	Titanium Coping, Bridge 023.2749	Titanium Coping, Bar 023.2750	Gold Coping, Bridge 023.2752	Gold Coping, Bar 023.2753	
Ø 4.6 mm							
<p>Engaging (Crown)</p>							
	Burn-out Coping 023.4748	Temporary TAN coping 024.0023	Titanium Coping 023.4747	Gold Coping 023.4753			
<p>Non-engaging (Bridges / Bars)</p>							
	Temporary TAN Coping, Bridge 024.0024	Coping, Ti, Bridge 023.4751	Coping, Ti, Bar 023.4752	Coping, Gold, Bridge 023.4754	Coping, Gold, Bar 023.4755	Variobase® for Bridge/Bar Cylindrical 023.0028	Burn-out Coping, for Variobase® for Bridge/Bar Cylindrical Coping 023.0032
Occlusal Screw 023.4763							



Preparation – Select the right abutment using the Plan abutments

Plan abutments for the CrossFit® screw-retained abutments are available in gingiva height (GH) 2.5mm and in orientations A and B.

Select the appropriate size of the abutment using the Plan set.



Plan abutments for TorcFit™ Screw-retained abutments are available in three different angulations: 0°, 17° and 30°. Each abutment has laser marking on the plan abutment itself, which shows corresponding gingiva heights.

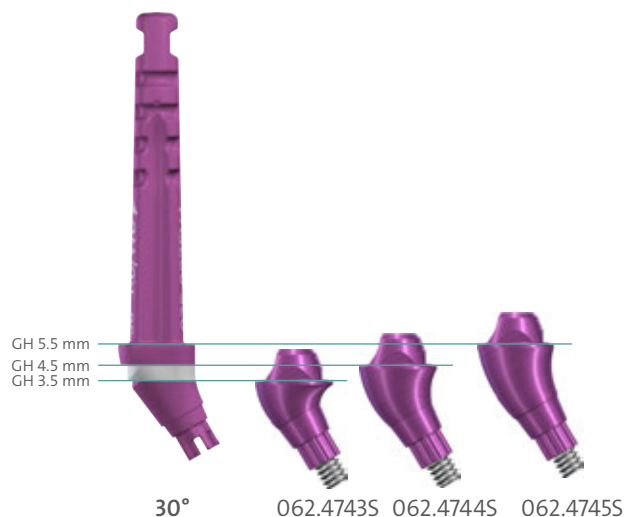
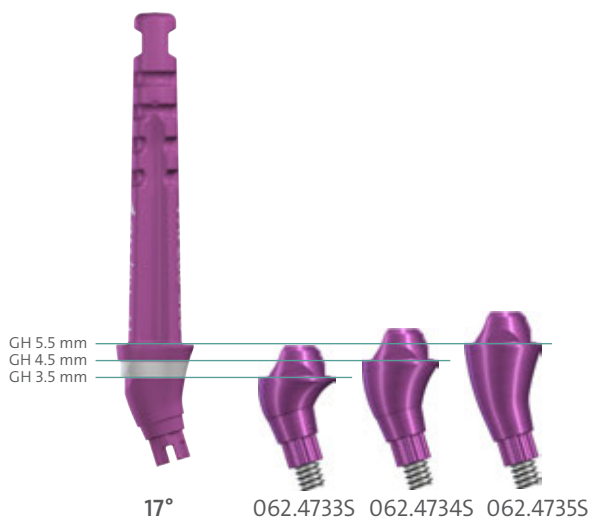
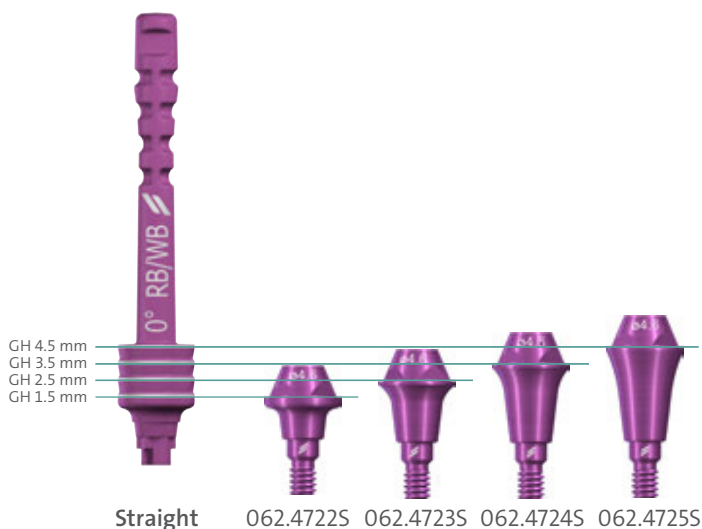

Preparation – Abutment placement

Clean and dry the interior of the implants thoroughly.

Position the abutments in the implants. Tighten them to 35 Ncm using the SCS screwdriver along with the ratchet and the torque control device.

For easier positioning of the abutments in the posterior region, make use of the Transfer and Alignment Pin.



Note: Do not modify the abutments. For processing in the dental lab use the Lab Processing screws.



7.7.1 Impression taking

General: It is recommended to take the impression on the level that the final restoration is planned on to ensure proper fit of the temporary and final restoration:

- Abutment-level impression for restoration on abutment level
- Implant-level impression for restoration on implant level



Impression-taking on abutment level

Open-tray impression

Make sure the abutments are torqued down with 35 Ncm. Place the open-tray impression posts onto the abutments and fix them with the screw.

Ensure correct positioning of the impression posts on the abutments.

For single-unit restoration use the impression components with the engaging feature, for multi-unit restorations use the impression components with the non-engaging feature.

Take the impression using an elastomeric impression material.

Forward the impression and all corresponding impression components to the dental lab.

Caution: unscrew the open-tray impression posts from Implants/abutments before releasing the impression material from the patient/model.

Note: Open-tray impression procedure requires a custom-made tray with perforations. Impression posts are intended for single use only to ensure optimal fit and precise impression taking for each patient.

Closed-tray impression

Make sure the abutments are torqued down with 35 Ncm.

Hand-tighten the closed-tray impression posts onto the abutments.

Ensure correct positioning of the impression posts on the abutments.

Position the positioning cap onto the impression post.



■ Prosthetic procedure



For single-unit restoration use the impression components with the engaging feature, for multi-unit restorations use the impression components with the non-engaging feature.

Take the impression using an elastomeric impression material.

Forward the impression and all corresponding impression components to the dental lab.



Impression taking on implant level

In case all implants are placed straight, there is the option of taking an implant-level impression (for instructions see chapter 6. *Impression taking*).

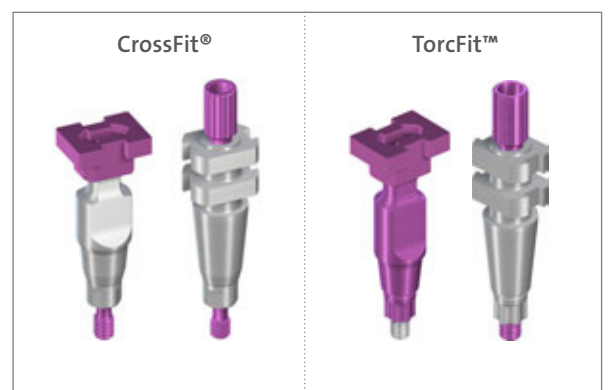

7.7.2 Single-unit restoration

Using protective caps

Mount the protective cap onto the abutment and hand-tighten the screws with the SCS screwdriver.

Note: Do not keep protective caps in the patient's mouth for longer than 180 days.



Protective caps are available in different shapes and heights, to be chosen according the patient anatomical situation and desired outcome.



- Lab procedure
- Prosthetic procedure



Temporary restoration

Using temporary TAN copings or titanium copings

Based on the dental impression prepare the master cast using the appropriate analog.

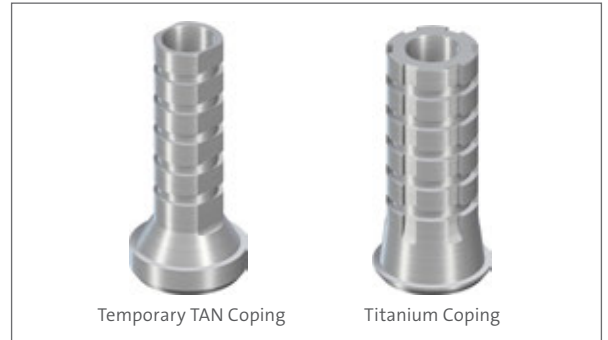

Place the coping with engaging features onto the analog.

Modify the coping according to the required length.



Optional: Sandblast the coping and coat it with opaquer to avoid Titanium/TAN shining through.

Warning: do not sandblast the inner configuration and connection portions of the copings.



Cover the screw channel with absorbent cotton or gutta-percha and seal the screw channel.

Use a standard procedure to create the temporary crown.



Remove excess material, re-open the screw channel of the coping and finalize the temporary crown.



- Lab procedure
- Prosthetic procedure



Finalized crown



Remove protective cap from the abutment in the patient's mouth.

Insert the provisional into the patient's mouth with a torque of 15Ncm.

Cover the screw channel with absorbent cotton or gutta-percha and seal the screw channel.



Note: Keep the temporary restoration out of occlusion.

Final restoration

Example using gold copings

- For this procedure use the gold coping with the engaging feature.

Fix the corresponding analog into the impression material from the patient's situation.



Note: Ensure that the color code of the analog corresponds to the color code of the impression components.

Fabricate the master cast using standard procedure (for instructions see chapter 6. *Impression taking*).

Model a full anatomic wax-up for optimal esthetic planning. Use the corresponding gold copings or burn-out copings as a base for the wax-up.



■ Lab procedure



Define the optimal shape of the restoration by making a silicone key over the full wax-up.

Place the gold coping on the analog and hand-tighten the occlusal screw using the SCS screwdriver.



Shorten the modeling aids to the height of the occlusal plane according to the individual situation. Working with the modeling aid ensures a clean and sharp-edged finish of the screw channel.



Fabricate the superstructure on the abutments using standard modeling procedure.

Make sure that the wax layer on the abutment is sufficiently thick (at least 0.7 mm). Do not cover the delicate margin of the coping with wax.



Check the spatial conditions before casting the crown framework with the silicone key of the wax-up.

Before investing the wax framework, make sure the framework is tension-free.



■ Lab procedure



Note: In order to avoid overflow of the cast-on alloy, clean the copings thoroughly prior to investment (removal of wax particles and insulating agents with a cotton pellet or brush moistened with alcohol).

Ensure that there is no wax on the delicate margin.

The use of investment materials for rapid heating methods (speed investment materials) is not recommended.

When processing the investment material, follow the manufacturer's instructions. Strictly observe the recommended mixing ratio and preheating time.

Make sure the screw channel and the internal configuration of the copings are filled with investment material from the bottom to the top in order to avoid air bubbles (see pictures).

Long-term success of the prosthetic work depends on the accurate fit of the restoration. The entire procedure will have to be repeated if casting errors occur.



- Lab procedure
- Prosthetic procedure



Invest the framework according to standard methods without using wetting agents.

Cast and invest the framework using standard methods.

Check for tension-free fitting on the master cast by applying the Sheffield test.

Do an additional try-on of the tensionfree fit of the crown in the patient's mouth.



Veneer the superstructure.



Note: Alternatively, burn-out copings may be used.

- Lab procedure
- Prosthetic procedure



7.7.3 Multi-unit restoration

Using the protective caps

Mount the protective caps onto abutments and hand-tighten the screws with the SCS screwdriver.

Note: Do not keep protective caps in the patient's mouth for longer than 180 days.

Protective caps are available in different shapes and heights, to be chosen according to the patient's anatomical situation and desired outcome.



Temporary restoration

Using temporary TAN copings or titanium copings

Based on the dental impression prepare the master cast using the appropriate analogs.

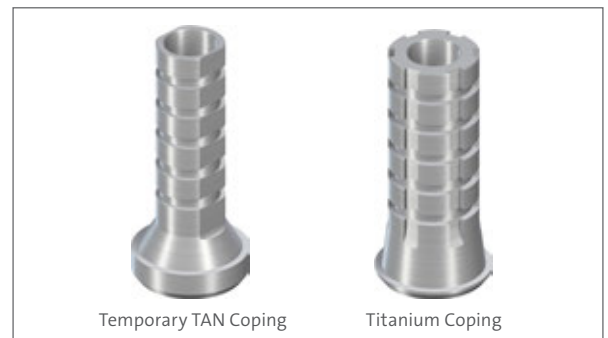

Place the copings with non-engaging features onto the analogs.



Modify the copings according to the required length.





Optional: Sandblast the copings and coat them with opaquer to avoid titanium/TAN shining through.

Warning: do not sandblast the inner configuration and connection portions of the copings.

Cover the screw channel with absorbent cotton or gutta-percha and seal the screw channel.

Use a standard lab procedure to create the temporary bridge.



Remove any excess material, re-open the screw channels and finalize the temporary bridge.



Remove the protective caps from the abutments in the patient's mouth.

Insert the temporary bridge into the patient's mouth applying a 15 Ncm torque.

Cover the screw channels with absorbent cotton or gutta-percha and seal the screw channel.

Note: Keep the temporary restoration out of occlusion.





Final restoration

Final restoration using CAD/CAM system

Fabricate the master cast using standard procedure (for instructions see chapter 6. *Impression taking*).

In order to transfer the impression data into the CARES® software use abutment-level scanbodies for the screw-retained abutments.

Hand-tighten the scanbodies onto the analogs in the dental model.



Place the dental model in the scanner and follow the scanning instructions.

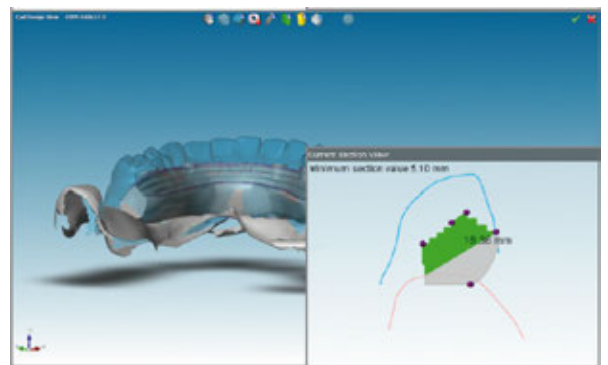
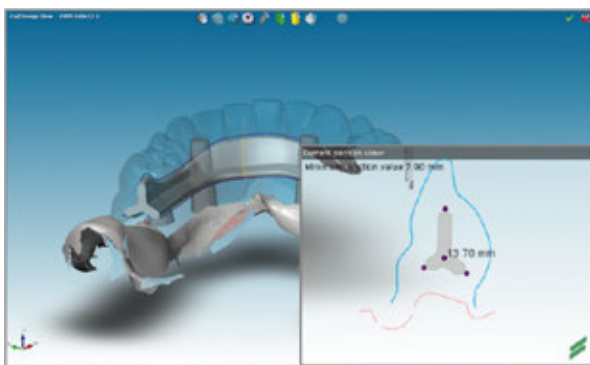

Design the framework in the software as needed.

Transfer the final design to the milling facilities.



Veneer the custom-milled superstructure.

In case you do not have access either to Straumann® CARES® or Createch, the final restoration can be prepared using standard procedure.



Example using gold copings

- For this procedure non-engaging gold copings are used.

Fix the corresponding analogs into the impression.



Note: Ensure that the color code of the analogs corresponds with the color code of the impression components.

Fabricate the master cast using standard procedure (for instructions see chapter 6. *Impression taking*).

Model a full anatomic wax-up for optimal esthetic planning. Use the corresponding gold copings or burn-out copings as a base for the wax-up.



Define the optimal shape of the restoration by making a silicone key over the full wax-up.



■ Lab procedure



Place the gold copings on the analogs and hand-tighten the occlusal screw using the SCS screwdriver.



Shorten the modeling aids to the height of the occlusal plane according to the individual situation. Working with the modeling aid ensures a clean and sharp-edged finish of the screw channel.



Fabricate the superstructure on the abutments using standard modeling procedures.

Make sure that the wax layer on the abutment is sufficiently thick (at least 0.7 mm). Do not cover the delicate margin of the coping with wax.



Check the spatial conditions before casting the crown framework with the silicone key of the wax-up.

Before investing the wax framework make sure the framework is tensionfree.



■ Lab procedure



Note: In order to avoid overflow of the cast-on alloy, clean the copings thoroughly prior to investment (removal of wax particles and insulating agents with a cotton pellet or brush moistened with alcohol).

Ensure that there is no wax on the delicate margin.

The use of investment materials for rapid heating methods (speed investment materials) is not recommended.

When processing the investment material, follow the manufacturer's instructions. Strictly observe the recommended mixing ratio and pre-heating time.

Make sure the screw channel and the internal configuration of the copings are filled with investment material from the bottom to the top in order to avoid air bubbles (see picture).

Long-term success of the prosthetic work depends on the accurate fit of the restoration. The entire procedure will have to be repeated if casting errors occur.



Invest the framework using standard procedure without using wetting agents.

Cast and deinvest the framework using standard procedure.

Check for tension-free fitting on the master cast by applying the Sheffield test. If the bridge is not tension-free and wiggles, cut the bridge and resplint tension-free.

- Lab procedure
- Prosthetic procedure



Do an additional try-on of the tensionfree fit of the bridge in the patient's mouth.



Veneer the superstructure.



Note: Alternatively, burn-out copings can be used.



7.7.4 Edentulous restoration: Fixed option with immediate temporary restoration

Using protective caps

Mount the protective caps on abutments and hand-tighten the screws with the SCS screwdriver.

Note: Do not keep protective caps in the patient's mouth for longer than 180 days.

Protective caps are available in different shapes and heights, to be chosen according to the patient's anatomical situation and desired outcome.



Temporary restoration

Using TAN copings or titanium copings

- In this case the preparation of an immediate provisional in the dental lab is shown.

Based on dental impression, prepare the master cast using standard procedure.

Based on the impression and bite registration, prepare the provisional denture.

For the surgical procedure, prepare a duplicate of the provisional in clear acrylic material.

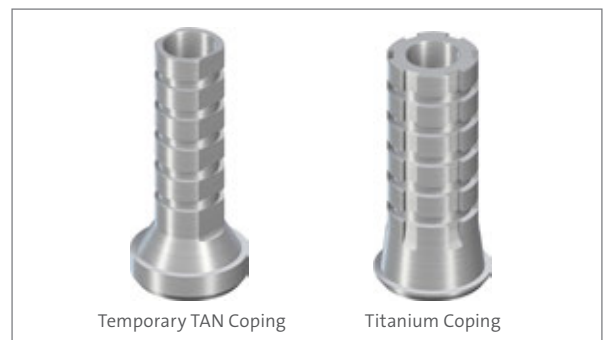

Temporary TAN or titanium copings will represent the implant position and angulation in the acrylic guide.

Note: For more detailed information on the surgical procedure, please see the *Straumann® Pro Arch, Basic Information (490.015/en)*.



- Lab procedure
- Prosthetic procedure



In the dental lab, prepare holes in the temporary denture according to the number of copings. Consider sufficient space for resin material.



Check if there is sufficient space for the copings.

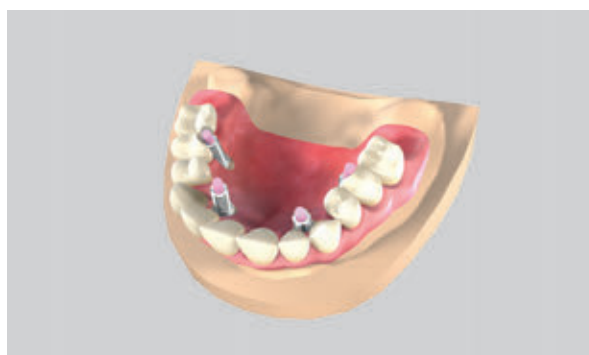

In the patient's mouth, connect the copings with the temporary prosthesis using resin material and transfer to the dental lab for finalizing.





In the dental lab, finalize and polish the temporary restoration.



Note: In order to protect the abutment configuration from resin flowing in, use the polishing aids.



Final restoration: Screw-retained – CAD/CAM option

Fabricate the master cast using standard procedure (for instructions see chapter 6. *Impression taking*).

In order to transfer the impression data into the CARES® software, use abutment-level scanbodies for the screw-retained abutments.



Hand-tighten the scanbodies onto the analogs in the dental model.



■ Lab procedure



Place the dental model in the scanner and follow the scanning instructions.

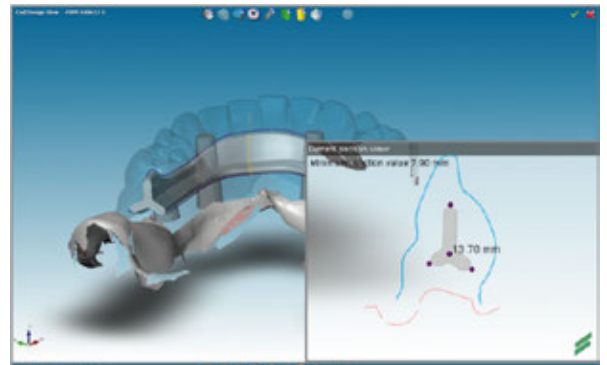
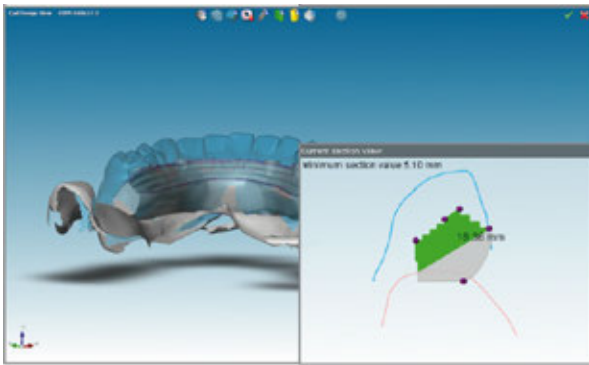

Design the framework for screw-retained restorations in the software as needed. Transfer the final design to the milling facility.

Example of a Straumann® CARES® Advanced Fixed Bar on 4 implants

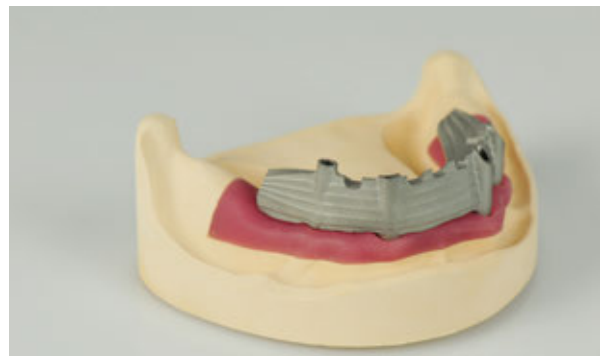

Example of a Straumann® CARES® Basic Fixed Bar on 4 implants





Veneer and finalize the custom-milled superstructure.

CARES® Advanced Fixed Bar



CARES® Basic Fixed Bar



- Lab procedure
- Prosthetic procedure



Final restoration: Conventional option

Final restoration: Removable – Conventional option

Using traditional Dolder® bars

Fix the corresponding analogs into the impression.

Note: Ensure that the color code of the analogs corresponds with the color code of the impression components.

Fabricate the master cast using standard procedure (for instructions see chapter 6. *Impression taking*).

Before placing the copings onto the master cast, we recommend mounting the occlusal screw onto the SCS screwdriver. Place the bar copings onto the master cast and hand-tighten with the occlusal screws.



Fabricate a soldered or laser-welded titanium bar using standard procedure.



Note: Use stabilization pins for the soldering of a gold bar.

Remove the temporary restoration before inserting the final restoration.

Clean the abutments thoroughly in the patient's mouth.

Check tension-free fit of the bar before tightening.

■ Prosthetic procedure



Tighten the occlusal screw to 15 Ncm using the SCS screwdriver with the ratchet and the torque control device.



Note: For more detailed information on Straumann® CARES® Basic and Advanced Fixed Bars, please refer to *Basic Information on CARES® Basic and Advanced Fixed Bars – Prosthetic Finalization* (490.042/en).

7.8 LOCATOR® Abutment

Application

- Dentures retained by implants in the mandible and maxilla

Characteristics

Simple

- Divergence compensation up to 40° between two implants
- Minimum component height for limited occlusal space

Reliable

- Dual retention for optimal abutment-denture connection
- Excellent long-term performance due to high wear resistance of components



Zest Anchors, LLC
2875 Loker Avenue East
Carlsbad • CA 92010 USA
(1) 760-743-7744
www.zestdent.com



MDSS GmbH
Schiffgraben 41
30175 Hannover,
Germany



LOCATOR and ZEST are registered trademarks and Zest Dental Solutions is a trademark of ZEST IP Holdings, LLC
U.S. Patents: Refer to www.zestdent.com/patents

- Lab procedure: pages 132-135
- Prosthetic procedure: pages 136-143

7.8.1 LOCATOR® Abutment – Lab procedure

Option A: Master cast from implant-level impression

Take the impression according to the instructions in *chapter 6*.

Step 1 – Selecting the abutment height

- Select the height of the LOCATOR® abutment by determining the height of the replica gingiva at its highest point on the master cast. Example: Pick the LOCATOR® abutment height 2 mm if the gingival height is 2 mm. The abutment is designed in a way that the top margin of the abutment will be 1 mm above the mucosa.

Note: Inserting the prosthesis is easier for the patient when the LOCATOR® abutments are on the same horizontal level.



Step 2 – Abutment insertion

- Screw the abutment hand-tight into the implant analog using the LOCATOR® driver.



Option B: Master cast from abutment-level impression

For abutment-level impression taking, special LOCATOR® analogs are used. The selection of the LOCATOR® abutments has already been made by the prosthodontist.

Step 1 – Female analog insertion

- Insert the LOCATOR® female analogs into the LOCATOR® impression copings.



Step 2 – Fabricating of the master cast

- Fabricate the master cast using standard procedure and type-4 dental stone (ISO 6873).



Construction of an overdenture with LOCATOR® denture housings

You can construct a new overdenture or upgrade an already existing and well-functioning overdenture with LOCATOR® components.

Option A: Construction of a new overdenture

Step 1 – Placing the white block-out spacers and denture caps

- Place one white block-out spacer over each abutment.
- Place the denture caps with the black processing males onto the LOCATOR® abutments, or the LOCATOR® analogs in the master cast.



Step 2 – Overdenture construction

- Construct the overdenture according to the standard procedure, adding the LOCATOR® denture housing.
- Return the completed overdenture to the doctor's office with the black processing males still in place.



Option B: Upgrading an existing overdenture

Step 1 – Placing the white block-out spacers and denture caps

- Place one white block-out spacer over each abutment.
- Place the denture caps with the black processing males onto the LOCATOR® abutments, or the LOCATOR® analogs in the master cast.



Step 2 – Hollowing out the denture base

- Hollow out the existing denture base in the areas of the LOCATOR® denture caps.



Step 3 – Over-denture rebase

- Rebase the over-denture according to the standard procedure, adding the LOCATOR® denture housing.
- Return to the dentist the completed over-denture with the black processing males still in place.



7.8.2 LOCATOR® Abutment – Prosthetic procedure (standard)

Impression taking

Option B: Abutment-level impression taking

For abutment-level impression taking, special LOCATOR® impression components are used. As a consequence, abutment heights are selected by the doctor on the patient.

Step 1 – Selecting the abutment height

- Make sure the top of the implant is not covered by hard or soft tissue.

Note: It is imperative that all hard and soft tissue is removed from the implant shoulder to ensure correct seating of the LOCATOR® abutment.

- Select the height of the LOCATOR® abutment by determining the height of the gingiva at its highest point in the patient's mouth. Choose the corresponding abutment tissue cuff height or the closest higher size available.

Note: Prosthesis insertion is easier for the patient if the LOCATOR® abutments are on the same horizontal level.



Step 2 – Abutment insertion

- Screw the abutment into the implant hand-tight, using the LOCATOR® driver.
- Tighten the abutment to 35 Ncm using the ratchet along with the torque control device (for instructions see chapter 8.5) and the LOCATOR® driver (see chapter 7.8.4).

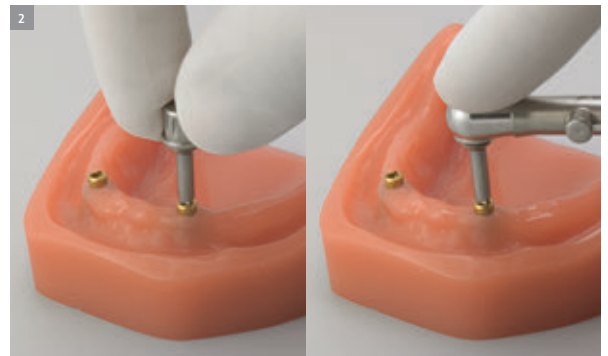

Step 3 – Placing spacer and impression coping

- Place a white block-out spacer ring on each abutment. The spacer ring is used to block out the area surrounding the abutment.
- Place the LOCATOR® impression copings on the LOCATOR® abutments.

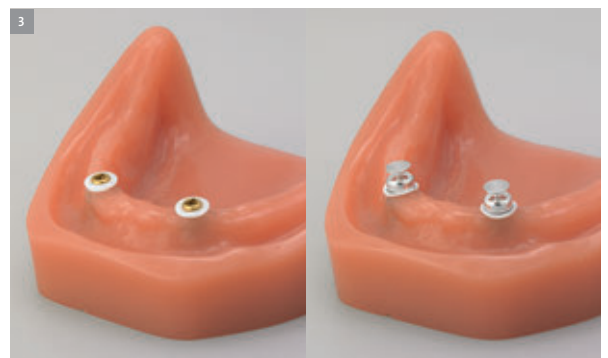

Step 4 – Impression taking

- Take the impression utilizing the mucodynamic technique (vinyl polysiloxane or polyether rubber).
- Send the impression to the dental laboratory.



Final restoration

The dental technician returns the completed LOCATOR® overdenture to the doctor's office for final placement. The finished denture is delivered with the black processing males still in place.



Step 1 – Selecting the replacement males

- Implant divergence up to 10° for a single implant:

Color	Retention
• blue	0.68 kg
• pink	1.36 kg
• clear	2.27 kg

- Implant divergence between 10° and 20° for a single implant:

Color	Retention
• gray	0.0 kg
• red	0.45 kg
• orange	0.91 kg
• green	1.82 kg

Note: Always start with the lowest retention replacement males (see chapter 7.8.4).

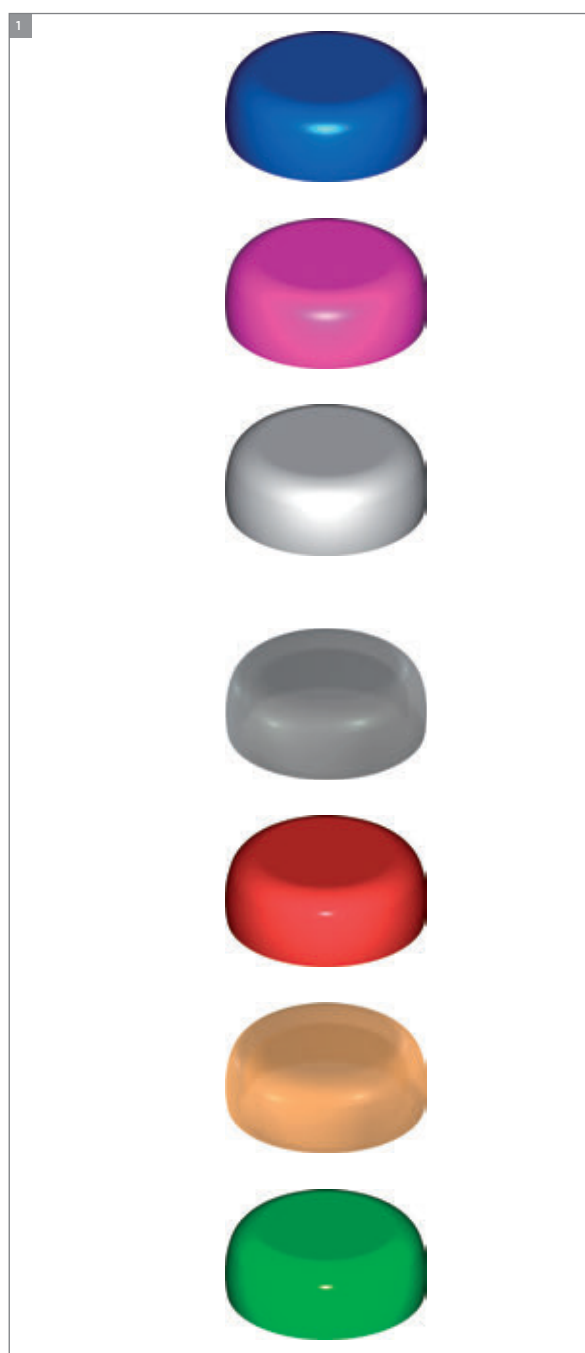

Step 2 – Removing the processing males

- Remove the black processing males from the housing (see chapter 7.8.4).



Step 3 – Inserting the replacement male

- Insert the replacement male with the core tool (see chapter 7.8.4).



Step 4 – Inserting the finished denture

- Insert the finished denture and check the occlusion.



7.8.3 LOCATOR® Abutment – Prosthetic procedure (chairside)

For an already existing and well-functioning overdenture, the LOCATOR® system can be used in a chair-side procedure.

Step 1 – Selecting the abutment height

- Make sure the top of the implant is not covered by the gingiva.
- Select the height of the LOCATOR® abutment by determining the height of the gingiva at its highest point. Example: Pick the LOCATOR® abutment height 2 mm if the gingival height is 2 mm. The abutment is designed in a way that the top margin of the abutment will be 1 mm above the mucosa.

Note: Prosthesis insertion is easier for the patient if the LOCATOR® abutments are on the same horizontal level.



Step 2 – Inserting the abutment

- Screw the abutment into the implant by hand using the LOCATOR® driver.
- Tighten the abutment to 35 Ncm using the ratchet along with the torque control device (for instructions see chapter 8.5) and the LOCATOR® driver attached (see chapter 7.8.4).

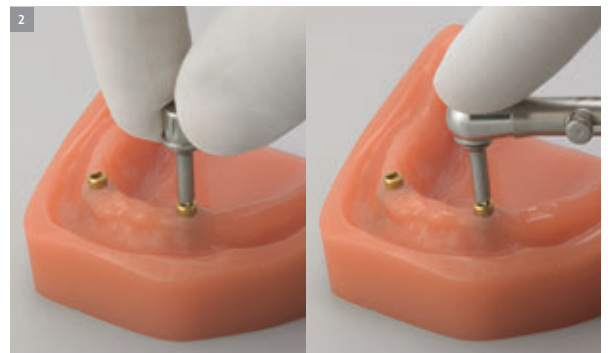

Step 3 – Placing the block-out spacer

- Place a white block-out spacer ring on the abutments. The spacer is used to block out the area surrounding the abutment.



Step 4 – Placing the denture caps

- Place the denture caps with the black processing males onto the LOCATOR® abutments.



Step 5 – Hollowing out the denture base

- Hollow out the existing denture base in the areas of the LOCATOR® denture caps.

Note: Ensure that the denture caps fixed on the abutments do not touch the prosthesis.



Step 6 – Filling the connecting holes

- Fill the connecting holes with prosthetic resin from lingual and anchor the caps in the denture (lightcure or selfcuring resin).
- Remove any excess resin after curing and polish the denture.

Note: If the white LOCATOR® block-out spacer does not completely fill the space between the gingiva and the denture caps, any remaining undercuts must be blocked out to prevent resin flowing under the caps. This can be accomplished by stacking two or more LOCATOR® block-out spacers.

Once the resin has cured, remove the denture from the mouth and discard the white LOCATOR® block-out spacers.

Step 7 – Selecting the replacement males

- Implant divergence up to 10° for a single implant:

Color	Retention
• blue	0.68 kg
• pink	1.36 kg
• clear	2.27 kg

- Implant divergence between 10° and 20° for a single implant:

Color	Retention
• gray	0.0 kg
• red	0.45 kg
• orange	0.91 kg
• green	1.82 kg

Note: Always start with the lowest retention replacement males.

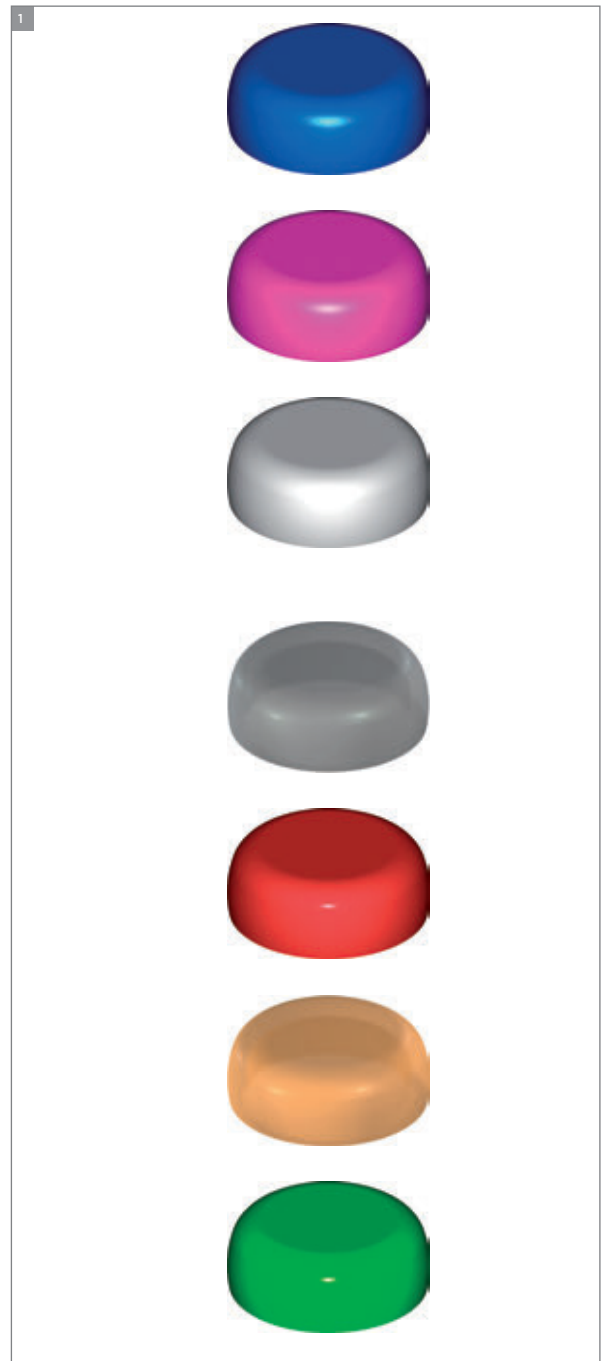

Step 8 – Removing the processing males

- To place the replacement males in the denture housing, remove the black processing males from the housing (see chapter 7.8.4).



Step 9 – Inserting the replacement male

- Insert the replacement male with the core tool (see chapter 7.8.4).



Step 10 – Inserting the finished denture

- Insert the finished denture and check the occlusion.



7.8.4 LOCATOR® Abutment – Further references

1. Using the LOCATOR® core tool

The LOCATOR® core tool is a three-piece multifunction instrument.



The tip is used for removing replacement males from the denture caps. To do this, unscrew the tip with two full turns. A gap is visible between the tip and the middle section.



In a straight line, guide the tip into the denture cap with a replacement male. The sharp edges of the tip hold the replacement male while it is being removed. Draw the instrument out of the denture cap in a straight line.

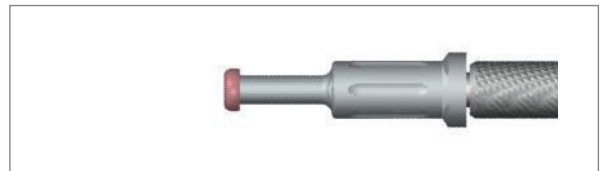

To remove the replacement male from the instrument, screw the tip clockwise completely onto the middle section. This activates the loosening pin inside the tip, which releases the replacement male.

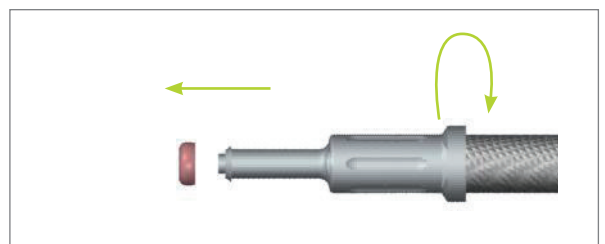

The LOCATOR® abutment holder sleeve makes it easier to deliver a LOCATOR® abutment, and it retains the abutment while threading it into the implant.

The LOCATOR® abutment holder sleeve can be autoclaved.



The middle section of the LOCATOR® core tool is used for inserting replacement males into the denture caps. To do this, unscrew the tip. Press the exposed end of the replacement male into the denture cap. You hear a click when the replacement male is fixed firmly in the cap.



The end (gold-colored) of the LOCATOR® core tool is used by the dental technician for screwing and unscrewing the LOCATOR® abutments to and from the analogs.



2. Determining the implant divergences

Snap the LOCATOR® parallel posts onto the LOCATOR® abutments. Use the LOCATOR® angle measurement guide to determine the angulation of the LOCATOR® abutments in relation to each other. Hold the angle measurement guide behind the placed parallel posts and read off the angle for each abutment.

Note: Choose the appropriate LOCATOR® replacement males according to the angulation measured for each abutment.

Tie dental floss through the lateral holes of the angle measurement guide to prevent aspiration.

3. Using the black processing male

Both the LOCATOR® female analog and the LOCATOR® denture cap are supplied with a preassembled black processing male. The black processing male functions as a space keeper for the various LOCATOR® replacement males. For the relining of a LOCATOR-anchored overdenture, the LOCATOR® replacement males must be removed from the denture caps and exchanged with black processing males. The black processing males keep the denture in a stable vertical position during the relining procedure. When the relining of the denture is finished, the black processing males are exchanged with the corresponding new LOCATOR® replacement males.



4. Important cleaning instructions

The proper cleaning of the LOCATOR®-borne denture and the LOCATOR® abutments is a prerequisite to ensure the long-term performance of both the abutments and the nylon processing inserts. An accumulation of plaque on the abutment that imbeds into the nylon processing insert can abrade, over time, the titanium abutment to a smaller diameter and thus cause it to lose retention. According to the specific situation, the patient might be put on shorter recall appointments to monitor the proper cleaning of the denture and the abutments.

8. Aids and instruments



8.1 SCS Screwdriver

The SCS* screwdriver is used for the fixation of the prosthetic parts and healing components. The star shape of the screwdriver tip connects to the top of the healing components and abutment screw heads for safe pick-up and handling.

*SCS = **S**crew **C**arrying **S**ystem

SCS screwdriver for manual use

Article: extra short, short, long

Lengths: 15 mm, 21 mm, 27 mm

Art. Nos.: 046.400, 046.401, 046.402

Material: Stainless steel



8.2 Polishing Aid

The polishing aid is used during polishing and other lab procedures to protect the abutment's prosthetic connection and to establish a convenient fixation extension.

Art. Nos.: 025.2920, 025.4920

Material: Stainless steel

Note: In the case of BLX, use an implant analog.





8.3 Ratchet and Torque Control Device

The ratchet (Art. No. 046.119) is a two-part lever arm instrument with a rotary knob for changing the direction of force. It is supplied with a service instrument (Art. No. 046.108), which is used to loosen the headed screw. After loosening, the ratchet bolt can be removed from the body of the ratchet. The ratchet must be disassembled for cleaning and disinfection. For sterilization the ratchet has to be re-assembled. To apply a certain torque when tightening a screw, use the ratchet together with the torque control device (Art. No. 046.049) and the holding key (Art. No. 046.064).

Ratchet

The ratchet is used in combination with the torque control device to torque in all Straumann abutments and screws (it is the same ratchet used for placing Straumann implants manually).

Note: The ratchet and service instrument are packaged together.

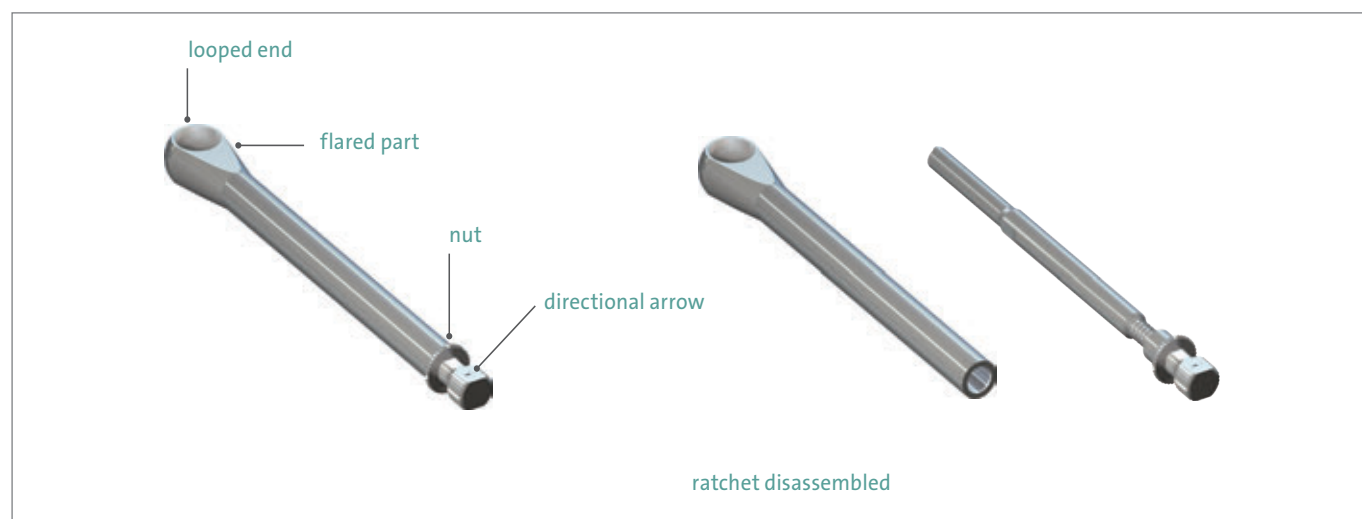



Torque control device

Connected to the ratchet, the torque control device is used to measure the value of Ncm (Newton centimeter) applied when inserting Straumann abutments and screws.

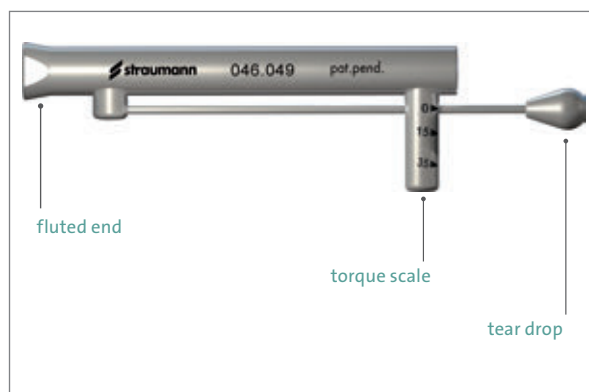

Service Instrument

The Service Instrument is used to assemble and disassemble the ratchet.



Holding key

The forked end of the holding key can be used to assemble and disassemble the ratchet. The pin can be used to stabilize drivers when abutments and screws are placed (also used for implant placement).



8.4 Assembling the Ratchet and the Torque Control Device

Step 1 – Loosening

- Loosen the ratchet nut with the service instrument or the holding key.



Step 2 – Removing

- Unscrew and remove the internal bolt from the ratchet body.

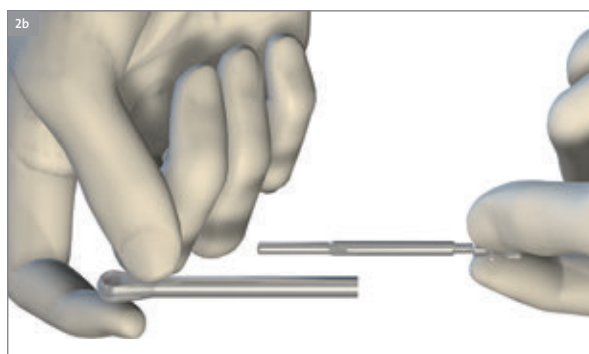
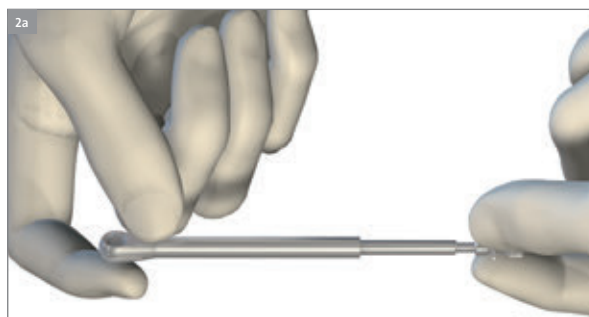



Step 3a – Insertion

- Insert the ratchet body into the torque control device (flared part of the ratchet must be flush with fluted end of torque control device).

Step 3b – Insertion

- Insert the internal bolt into the opposite end of the torque control device. Tighten it firmly by hand.

Step 4 – Tightening

- Tighten the nut of the ratchet with the service instrument or the holding key. Do not overtighten.

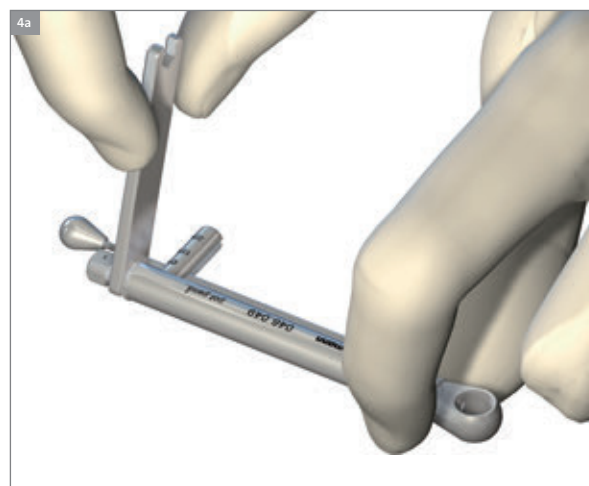

- The ratchet and torque control device are now assembled and ready for use.



8.5 Tightening an abutment to 35 Ncm

Step 1 – Insertion and tightening

- Insert the abutment into the implant.
- Tighten the abutment screw by hand using the SCS screwdriver.

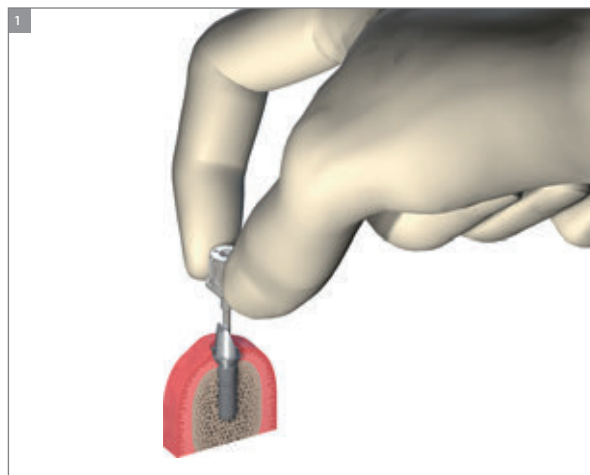

Step 2 – Placing the ratchet

- Place the looped end of the assembled ratchet with the torque control device over the driver handle. The directional arrow must be pointing in the clockwise direction (towards the torque bar with tear drop). If not, pull the arrow out, flip it over, and let it snap in.



Step 3 – Stabilizing the ratchet

- For stabilization, put the pin end of the holding key into the coronal hole on the driver handle.

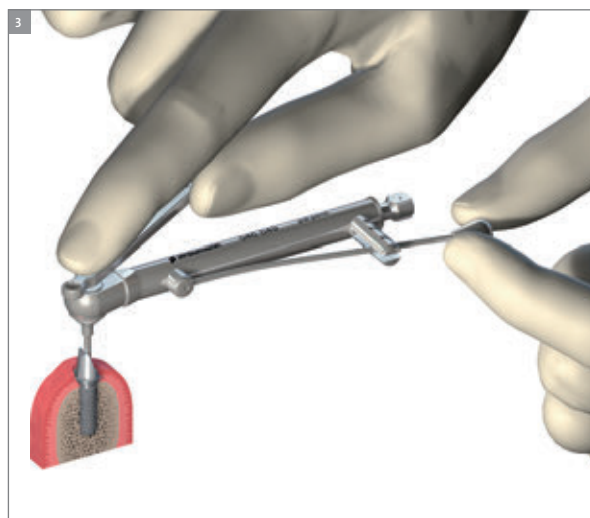



Step 4 – Positioning of appropriate Ncm mark

- Use one hand to hold the holding key and use the other hand to hold the torque bar. Grasp only the tear drop and move the torque bar to the 35 Ncm mark.



Step 5 – Removing the ratchet

- After reaching the 35 Ncm mark, return the torque bar to its starting position.
- Lift and remove the holding key, the ratchet with torque control device and the driver.

Note: Proper care and maintenance are important to ensure correct function of the ratchet and torque control device. Always clean and disinfect disassembled and sterilize assembled.

For detailed instructions on how to care for these instruments, please refer to their package inserts.

Recommended tightening torques

Hand-tight	15 Ncm	15–35 Ncm	35 Ncm
Closure screws Healing abutments	Temporary copings Copings	Temporary abutments	Final abutments

9. Cleaning, Disinfection and Sterilization



With the exception of the Screw-retained Abutment Sterile and Immediate Temporary Abutment, Straumann® abutments and components are not sterile when delivered. Use the procedure for cleaning, disinfection and sterilization prior to intra-oral use as defined in the respective IFU.

Note: Use devices directly after sterilization. Do not store sterilized devices.

10. Important guidelines



Please note

Practitioners must have appropriate knowledge and instruction in the handling of the Straumann® Dental Implant System for using the Straumann Products safely and properly in accordance with the instructions for use.

The Straumann Product must be used in accordance with the instructions for use provided by the manufacturer. It is the practitioner's responsibility to use the device in accordance with these instructions for use and to determine, if the device fits to the individual patient situation.

The Straumann Products are part of an overall concept and must be used only in conjunction with the corresponding original components and instruments distributed by Institut Straumann AG, its ultimate parent company and all affiliates or subsidiaries of such parent company ("Straumann"), except if stated otherwise in this document or in the instructions for use for the respective Straumann Product. If use of products made by third parties is not recommended by Straumann in this document or in the respective instructions for use, any such use will void any warranty or other obligation, express or implied, of Straumann.

Availability

Some of the Straumann Products listed in this document may not be available in all countries.

Caution

In addition to the caution notes in this document, our products must be secured against aspiration when used intraorally.

Validity

Upon publication of this document, all previous versions are superseded.

Documentation

For detailed instructions on the Straumann Products contact your Straumann representative.

Copyright and trademarks

Straumann® documents may not be reprinted or published, in whole or in part, without the written authorization of Straumann. Straumann® and/or other trademarks and logos from Straumann® mentioned herein are the trademarks or registered trademarks of Straumann Holding AG and/or its affiliates.

Ceramicor® is a registered trademark of Cendres + Métaux SA, Switzerland. IPS e.max®, IPS e.max® Ceram, IPS e.max® ZirPress, IPS e.max® Ceram ZirLiner, IPS e.max® Ceram Liner are registered trademarks of Ivoclar Vivadent AG, Liechtenstein. LOCATOR® is a registered trademark of Zest IP Holdings LLC, USA. Dolder® is a registered trademark from Prof. Eugen Dolder, exclusively licensed to Cendres + Métaux Holding SA, Switzerland. Ackermann® is a registered trademark licensed to Cendres + Métaux Holding SA, Switzerland. MP-Clip® is a registered trademark licensed to Cendres + Métaux Holding SA, Switzerland. VITA CAD-Temp® is a registered trademark of VITA Zahnfabrik H.Rauter GmbH & Co. KG. Elitor®/Pekkton® is a registered trademark of Cendres + Métaux SA. Createch Medical is a trademark registered by Createch Medical, SL.

International Headquarters

Institut Straumann AG

Peter Merian-Weg 12

CH-4002 Basel, Switzerland

Phone +41 (0)61 965 11 11

Fax +41 (0)61 965 11 01

www.straumann.com

© Institut Straumann AG, 2022. All rights reserved.

Straumann® and/or other trademarks and logos from Straumann® mentioned herein are the trademarks or registered trademarks of Straumann Holding AG and/or its affiliates.