

# SELECTION GUIDE

Straumann® Modular Cassette

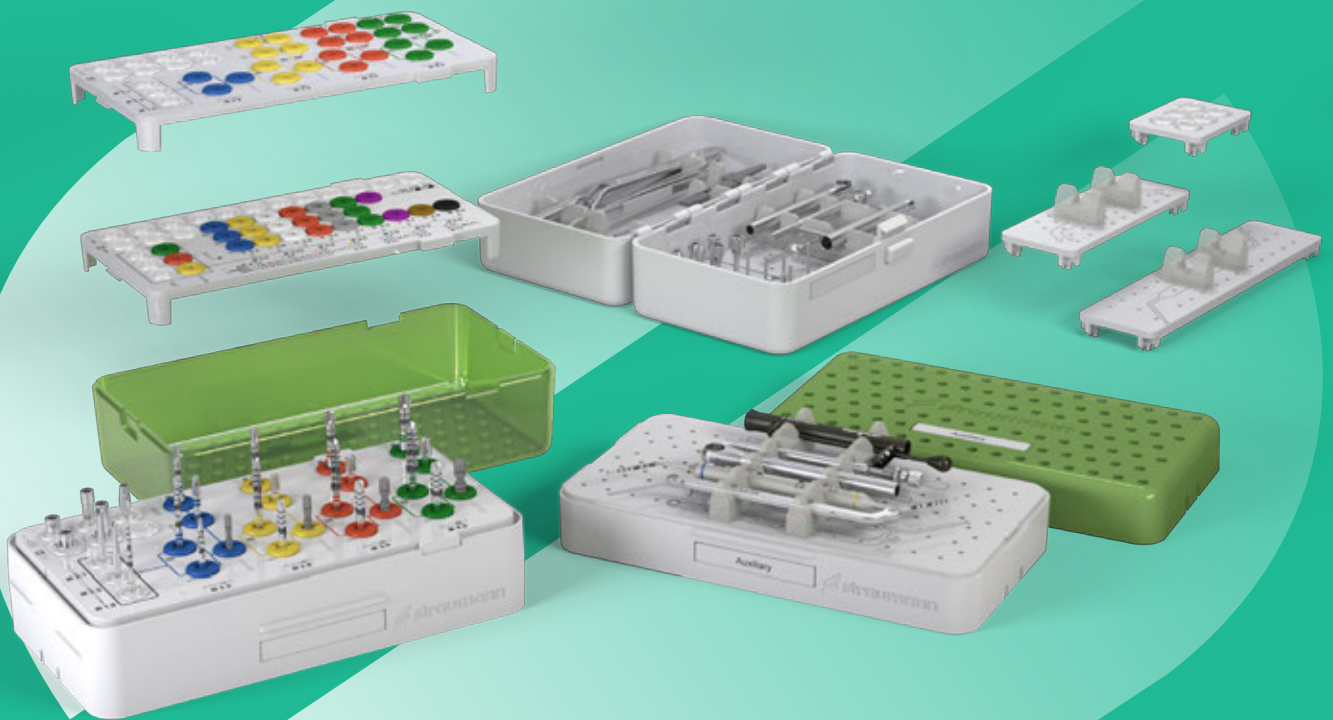



# CONTENT

C Module Auxiliary Cassette	3
A Module Full List	4
Standard Plus (SP), Standard Plus Short (SPS), Bone Level (BL)	9
Standard Plus (SP) Guided, Standard Plus Short (SPS) Guided, Bone Level (BL) Guided	13
Straumann® PURE Ceramic Implant System (CIM/CI)	19
Bone Level Tapered (BLT)	24
Bone Level Tapered (BLT) Guided	28
Straumann® iEXCEL (BLX, TLX; BLC, TLC)	34
BLC, TLC	38
Straumann® iEXCEL (BLX, TLX; BLC, TLC) Guided	40
TLX, BLX	45
TLX, BLX Guided	49

# PURPOSE OF THIS GUIDE

The selection guide helps to define the required Modular Cassette parts and instruments needed for a specific indication. Each chapter includes an order list as well as a set-up overview which shows how to assemble the parts.

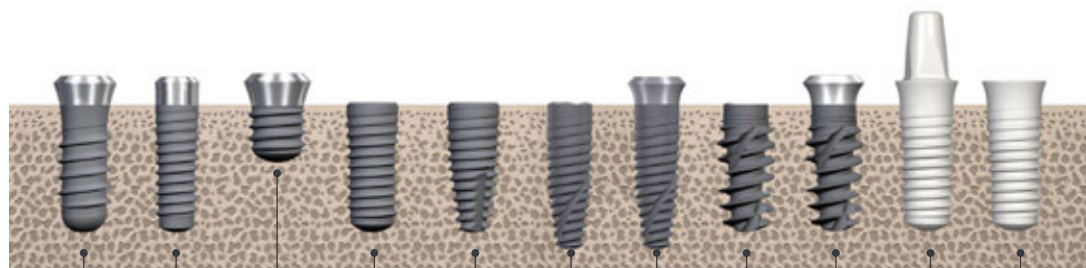

	SP	SP NNC	SPS	BL	BLT	BLC	TLC	BLX	TLX	CIM	CI
	.....	.....	.....	.....	.....	.....	.....	.....	.....	.....	.....
Freehand surgery	p. 9	p. 9	p. 9	p. 9	p. 24	p. 34	p. 34	p. 45	p. 45	p. 19	p. 19
Guided surgery	p. 13	p. 13	p. 3	p. 13	p. 28	p. 40	p. 40	p. 49	p. 49	*	*

\* For Straumann® PURE Ceramic Implant System using guided surgery, please use the SP/SPS/BL guided surgery instrument setup (page 13) for guided implant bed preparation. For implant placement use the CIM/CI freehand instrument set-up (page 19).

# C MODULE AUXILIARY CASSETTE

This chapter shows an alternative to the A module, for a simple and lean setup.

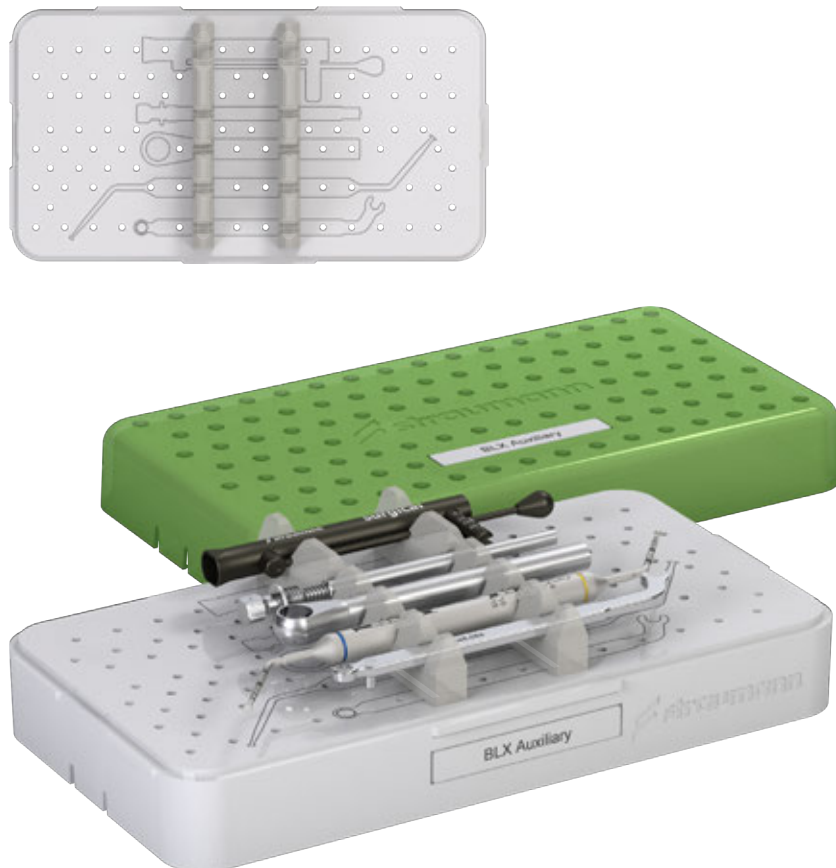

C-Module Auxiliary Cassette		
Art. No.	Image	Product
041.783		C-Module Auxiliary Cassette
046.119		Ratchet
066.1100		Torque Control Device, 35 Ncm, 50 Ncm, 80 Ncm
046.064		Holding Key
066.2000		Implant Depth Gauge

# A MODULE FULL LIST

This chapter shows all mandatory *and* optional instruments for the A Module.





## A MODULE

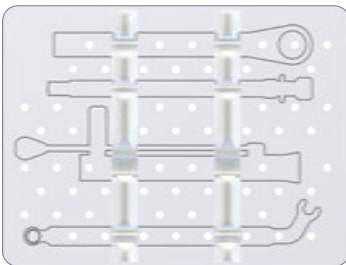

A Module		
Art. No.	Image	Product
041.761		Straumann® Modular Cassette, A Module

## RATCHET TRAY



Ratchet Tray		
Art. No.	Image	Product
041.766		A Modul Ratchet Tray
046.119		Ratchet
046.049		Torque Control Device, 15 Ncm, 35 Ncm
066.1100		Torque Control Device, 35 Ncm, 50 Ncm, 80 Ncm
046.064		Holding Key

## RELEASE AID FOR LOXIM® TRAY

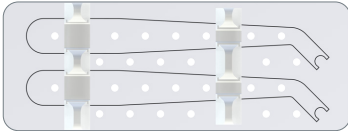

Release Aid Tray			
Art. No.	Image	Product	Indication
041.767		Release Aid Tray	
026.0073		Release Aid S for Loxim®	BLT SC
026.2558		Release Aid N for Loxim®	S, SP, TE, BL, BLT
026.4558		Release Aid R/W for Loxim®	S, SP, TE, BL, BLT

## STOP KEY TRAY

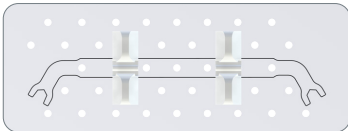

Stop Key Tray		
Art. No.	Image	Product
041.768		Stop Key Tray
034.006		Stop Key, guided

## TWEEZER TRAY

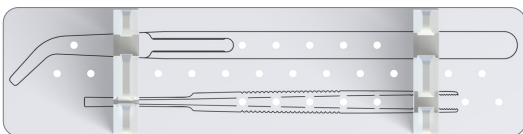



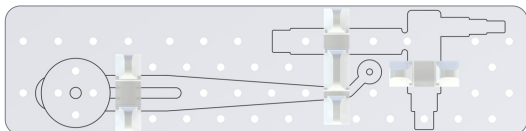

Tweezer Tray		
Art. No.	Image	Product
041.770		Tweezer Tray
046.095		Tweezers without titanium plasma-coated tips
046.820		Instrument tweezer

## PLANNING AID TRAY





Planning Aid Tray

Art. No.	Image	Product	Indication
041.769		Planning Aid Tray	
046.147		Diagnostic T	S, SP, TE, CIM/CI, BL, BLT
046.148		Tissue Level Implant Distance Indicator	S, SP, TE, CIM/CI
026.0901		Bone Level Implant Distance Indicator	BL, BLT

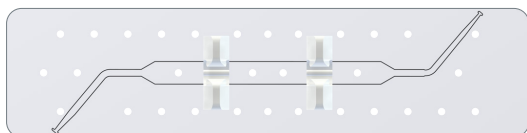
## IMPLANT DEPTH GAUGE TRAY



Implant Depth Gauge Tray

Art. No.	Image	Product
041.771		Implant Depth Gauge Tray
066.2000		Implant Depth Gauge



## SCS SCREWDRIVER SET



SCS Screwdriver Set		
Art. No.	Image	Product
041.764		Grommet Tray, 3 small + 3 large
046.400		SCS Screwdriver for Ratchet, extra-short
046.401		SCS Screwdriver for Ratchet, short
046.402		SCS Screwdriver for Ratchet, long
046.410		SCS Screwdriver for Handpiece, extra-short
046.411		SCS Screwdriver for Handpiece, short
046.412		SCS Screwdriver for Handpiece, long

## AS SCREWDRIVER SET



AS Screwdriver Set		
Art. No.	Image	Product
041.764		Grommet Tray, 3 small + 3 large
046.789		AS Screwdriver for Handpiece, extra-short
046.790		AS Screwdriver for Handpiece, short
046.791		AS Screwdriver for Handpiece, long
046.786		AS Screwdriver for Ratchet, extra-short*
046.787		AS Screwdriver for Ratchet, short*
046.788		AS Screwdriver for Ratchet, long*

\* Store the handling aid of the AS Screwdriver for Ratchet separately in the 041.765 Grommet tray

## BONE PROFILER SET



Bone Profiler Set			
Art. No.	Image	Product	Indication
041.762		Grommet Tray 6 small	
044.304		Bone Profiler RN/RT	S, SP, TLX
044.305		Bone Profiler WN/WT	
026.0070		Bone Profiler, oval Platform SC	BLT SC Ø2.9 mm
026.0022		BL Bone Profiler 1	BL, BLT, BLX
026.0023		BL Bone Profiler 2	
026.0024		BL Bone Profiler 3	

## 48H TOOL



48h Tool			
Art. No.	Image	Product	Indication
041.763		Grommet Tray 6 large	
80103		48 hour Explantation Device RN/WN	S, SP, TE
80087		48 hour Explantation Device RN/WN	
031.080		48 hour Explantation Device, Straumann® PURE Ceramic Implant (Monotype) RD	CIM/CI
031.081		48 hour Explantation Device, Straumann® PURE Ceramic Implant (Monotype) ND	
032.053		48h Explantation Device, Straumann® PURE Ceramic Implant RD	
026.0072		48 hour Explantation Device SC	BLT
026.2048		48 hour Explantation Device NC	BL, BLT
026.4048		48 hour Explantation Device RC	
049.361		48 hour Explantation Device NNC	NNC
066.4205		TorcFit™ Implant Driver for Ratchet, short	BLX, TLX
066.4206		TorcFit™ Implant Driver for Ratchet, long	

\* Note: CIM/CI PURE 48h explantation devices are for single use only.



# Order List: Standard Plus, Standard Plus Short, Bone Level

## A MODULE – ORDER LIST

SP Standard Plus / SPS Standard Plus Short / BL Bone Level		
Art. No.	Image	Product
041.761		Straumann® Modular Cassette, A Module
041.766		A Modul Ratchet Tray
046.119		Ratchet
046.049		Torque Control Device
046.064		Holding Key
041.767		Release Aid Tray
026.2558		Release Aid N for Loxim®
026.4558		Release Aid R/W for Loxim®
041.764		Grommet Tray, 3 small + 3 large
046.400		SCS Screwdriver for Ratchet, extra-short
046.401		SCS Screwdriver for Ratchet, short
046.402		SCS Screwdriver for Ratchet, long
046.410		SCS Screwdriver for Handpiece, extra-short
046.411		SCS Screwdriver for Handpiece, short
046.412		SCS Screwdriver for Handpiece, long

## A MODULE TISSUE LEVEL SPECIFIC TOOLS

Add for Standard Plus and Standard Plus Short Implant line

SP Standard Plus / SPS Standard Plus Short / BL Bone Level		
Art. No.	Image	Product
041.764		Grommet Tray, 3 small + 3 large
044.304		Bone Profiler RN/RT
044.305		Bone Profiler WN/WT
80103		48 hour Explantation Device RN/WN
80087		48 hour Explantation Device RN/WN

## A MODULE BONE LEVEL SPECIFIC TOOLS

Add for Bone Level Implant Line

SP Standard Plus / SPS Standard Plus Short / BL Bone Level		
Art. No.	Image	Product
041.764		Grommet Tray, 3 small + 3 large
026.0022		BL Bone Profiler 1
026.0023		BL Bone Profiler 2
026.0024		BL Bone Profiler 3
026.2048		48 hour Explantation Device NC
026.4048		48 hour Explantation Device RC

For additional tools (planning aid, tweezers, AS Screwdriver), please refer to page 4 *A Module full list*.



# Order List: Standard Plus, Standard Plus Short, Bone Level

## B MODULE – ORDER LIST

SP Standard Plus / SPS Standard Plus Short / BL Bone Level		
Art. No.	Image	Product
041.776		Straumann® Modular Cassette, B Module
041.779		B Module, Parallel Walled Tray
040.563		Drill extender
044.003		Round bur, Ø2.3 mm
044.004		Round bur, Ø3.1 mm
026.0056		Needle drill, long, Ø1.6 mm
044.783*		Pilot Twist Drill PRO, short, Ø2.2 mm
044.787*		Twist Drill PRO, short, Ø2.8 mm
044.791*		Twist Drill PRO, short, Ø3.5 mm
044.795*		Twist Drill PRO, short, Ø4.2 mm
044.785*		Pilot Twist Drill PRO, long, Ø2.2 mm
044.789*		Twist Drill PRO, long, Ø2.8 mm
044.793*		Twist Drill PRO, long, Ø3.5 mm
044.797*		Twist Drill PRO, long, Ø4.2 mm
046.799		Alignment Pin, Ø2.2 mm
046.800		Depth Gauge, Ø2.8 mm
046.802		Depth Gauge, Ø3.5 mm
046.804		Depth Gauge, Ø4.2 mm

046.460		Adapter for Ratchet, extra-short
046.461		Adapter for Ratchet, short
046.470		Adapter for Handpiece, extra-short
046.471		Adapter for Handpiece, short

## B MODULE TISSUE LEVEL SPECIFIC TOOLS

Add for Standard Plus and Standard Plus Short Implant line

SP Standard Plus / SPS Standard Plus Short / BL Bone Level		
Art. No.	Image	Product
034.332		SP Profile Drill, short, Ø3.3 mm, FIBA compatible
034.333		SP Profile Drill, short, Ø4.1 mm, FIBA compatible
044.084		SP Profile Drill, short, Ø4.8 mm, FIBA compatible
034.351		S/SP Tap, short, Ø3.3 mm, FIBA compatible
034.352		S/SP Tap, short, Ø4.1 mm, FIBA compatible
034.353		S/SP Tap, short, Ø4.8 mm, FIBA compatible

## B MODULE BONE LEVEL SPECIFIC TOOLS

Add for Bone Level Implant Line

SP Standard Plus / SPS Standard Plus Short / BL Bone Level		
Art. No.	Image	Product
034.327		BL/NNC Profile Drill, short, Ø3.3 mm, FIBA compatible
034.328		BL Profile Drill, short, Ø4.1 mm, FIBA compatible
034.329		BL Profile Drill, short, Ø4.8 mm, FIBA compatible
034.348		BL/NNC Tap, short, Ø3.3 mm, FIBA compatible
034.349		BL Tap, short, Ø4.1 mm, FIBA compatible
034.350		BL Tap, short, Ø4.8 mm, FIBA compatible

\* Not all products are available in all countries. For further information, please refer to *Straumann® Dental Implant System, Basic information (702084/en)*.



# A Module Set-up: Standard Plus, Standard Plus Short, Bone Level

A Module  
041.761

**Ratchet Tray**  
041.766

- Ratchet 046.119
- Torque Control 046.049
- Holding Key 046.064

**Release Aid Tray**  
041.767

- Release Aid N 026.2558
- Release Aid R/W 026.4558

**SCS Screwdriver Set**  
Grommet Tray 3 small + 3 large  
041.764

- SCS Screwdriver for ratchet  
046.400  
046.401  
046.402
- SCS Screwdriver for Handpiece  
046.410  
046.411  
046.412

**Tissue Level Auxiliary Set**  
Grommet Tray 3 small + 3 large  
041.764

- 48 hour Tool RN/WN 80103 80087
- Bone Profiler RN/RT 044.304
- Bone Profiler WN/WT 044.305

**Bone Level Auxiliary Set**  
Grommet Tray 3 small + 3 large  
041.764

- 48 hour Tool NC 026.2048
- 48 hour Tool RC 026.4048
- BL Bone Profiler 026.0022 026.0023 026.0024



# B Module Set-up: Standard Plus, Standard Plus Short, Bone Level

Parallel Walled Tray  
041.779

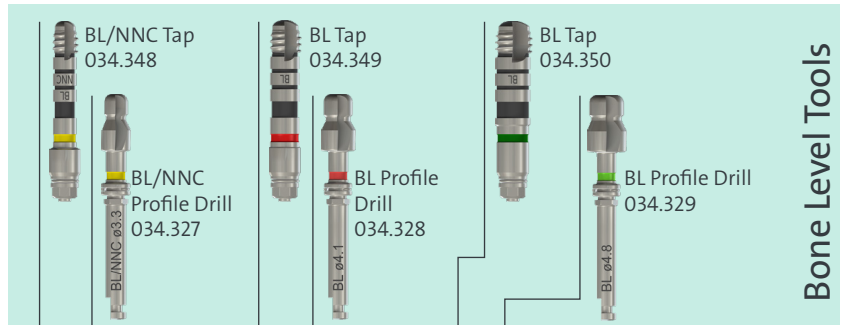

Bone Level Tools

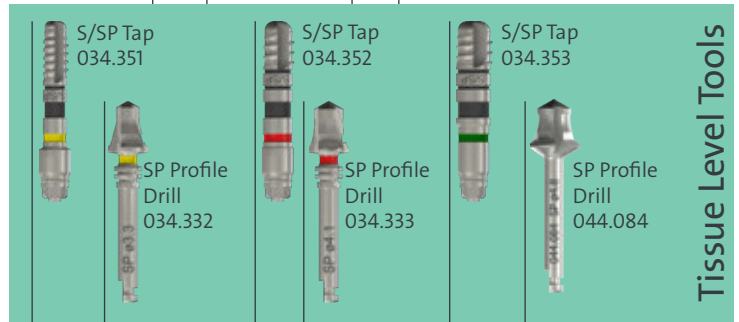

Tissue Level Tools

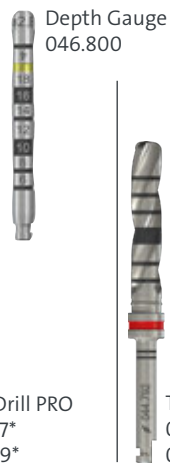
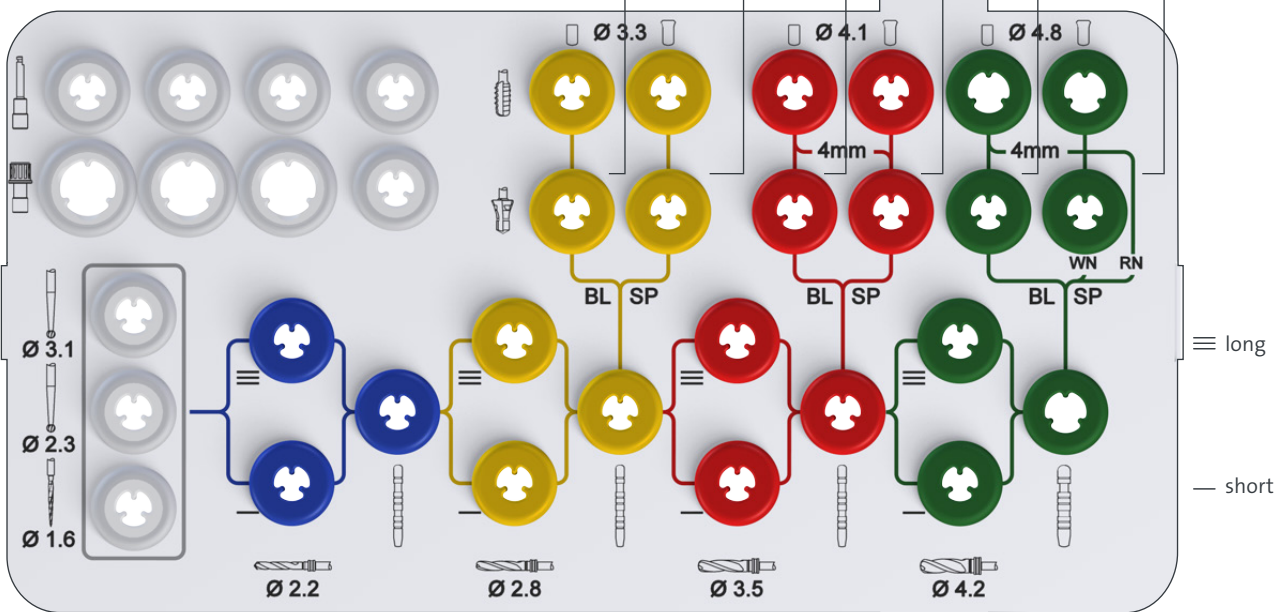



# Order List: Standard Plus, Standard Plus Short, Bone Level Guided

## A MODULE – ORDER LIST

SP Standard Plus / SPS Standard Plus Short / BL Bone Level		
Art. No.	Image	Product
041.761		Straumann® Modular Cassette, A Module
041.766		A Modul Ratchet Tray
046.119		Ratchet
046.049		Torque Control Device
046.064		Holding Key
041.767		Release Aid Tray
026.2558		Release Aid N for Loxim®
026.4558		Release Aid R/W for Loxim®
041.764		Grommet Tray, 3 small + 3 large
046.400		SCS Screwdriver for Ratchet, extra-short
046.401		SCS Screwdriver for Ratchet, short
046.402		SCS Screwdriver for Ratchet, long
046.410		SCS Screwdriver for Handpiece, extra-short
046.411		SCS Screwdriver for Handpiece, short
046.412		SCS Screwdriver for Handpiece, long

## A MODULE TISSUE LEVEL SPECIFIC TOOLS

Add for Standard Plus and Standard Plus Short Implant line

SP Standard Plus / SPS Standard Plus Short / BL Bone Level		
Art. No.	Image	Product
041.764		Grommet Tray, 3 small + 3 large
044.304		Bone Profiler RN/RT
044.305		Bone Profiler WN/WT
80103		48 hour Explantation Device RN/WN
80087		48 hour Explantation Device RN/WN

## A MODULE BONE LEVEL SPECIFIC TOOLS

Add for Bone Level Implant Line

SP Standard Plus / SPS Standard Plus Short / BL Bone Level		
Art. No.	Image	Product
041.764		Grommet Tray, 3 small + 3 large
026.0022		BL Bone Profiler 1
026.0023		BL Bone Profiler 2
026.0024		BL Bone Profiler 3
026.2048		48 hour Explantation Device NC
026.4048		48 hour Explantation Device RC

For additional tools (planning aid, tweezers, AS Screwdriver), please refer to page 4 *A Module full list*.



# Order List: Standard Plus, Standard Plus Short, Bone Level Guided

## B MODULE – ORDER LIST

SP Standard Plus / SPS Standard Plus Short / BL Bone Level		
Art. No.	Image	Product
041.776		Straumann® Modular Cassette, B Module
041.782		B Module, Guided Parallel Walled Tray
034.010		Mucosa Punch, Ø 3.4 mm
034.011		Mucosa Punch, Ø 4.0 mm
034.012		Mucosa Punch, Ø 4.7 mm
034.215		Milling Cutter, Ø 2.8 mm
034.415		Milling Cutter, Ø 3.5 mm
034.615		Milling Cutter, Ø 4.2 mm
044.783*		Pilot Twist Drill PRO, short, Ø 2.2 mm
044.787*		Twist Drill PRO, short, Ø 2.8 mm
044.791*		Twist Drill PRO, short, Ø 3.5 mm
044.795*		Twist Drill PRO, short, Ø 4.2 mm
044.784*		Pilot Twist Drill PRO, medium, Ø 2.2 mm
044.788*		Twist Drill PRO, medium, Ø 2.8 mm
044.792*		Twist Drill PRO, medium, Ø 3.5 mm
044.796*		Twist Drill PRO, medium, Ø 4.2 mm
044.785*		Pilot Twist Drill PRO, long, Ø 2.2 mm
044.789*		Twist Drill PRO, long, Ø 2.8 mm
044.793*		Twist Drill PRO, long, Ø 3.5 mm
044.797*		Twist Drill PRO, long, Ø 4.2 mm
046.799		Alignment Pin, Ø 2.2 mm, BLT
046.800		Depth Gauge, Ø 2.8 mm, BLT
046.802		Depth Gauge, Ø 3.5 mm, BLT
046.804		Depth Gauge, Ø 4.2 mm, BLT
034.354		Guided Adapter for profile drill, FIBA, H2
034.355		Guided Adapter for profile drill, FIBA, H4
034.356		Guided Adapter for profile drill, FIBA, H6

034.357		Guided Adapter for tap, FIBA, H2
034.358		Guided Adapter for tap, FIBA, H4
034.359		Guided Adapter for tap, FIBA, H6

## B MODULE BONE LEVEL SPECIFIC TOOLS

Add for Bone Level Implant Line

SP Standard Plus / SPS Standard Plus Short / BL Bone Level		
Art. No.	Image	Product
034.327		BL/NNC Profile Drill, short, Ø 3.3 mm, FIBA compatible
034.328		BL Profile Drill, short, Ø 4.1 mm, FIBA compatible
034.329		BL Profile Drill, short, Ø 4.8 mm, FIBA compatible
034.348		BL/NNC Tap, short, Ø 3.3 mm, FIBA compatible
034.349		BL Tap, short, Ø 4.1 mm, FIBA compatible
034.350		BL Tap, short, Ø 4.8 mm, FIBA compatible
026.0083		BL/BLT Guided Adapter, for handpiece
026.0084		BL/BLT Guided Adapter, for ratchet

## B MODULE TISSUE LEVEL SPECIFIC TOOLS

Add for Standard Plus and Standard Plus Short Implant line

SP Standard Plus / SPS Standard Plus Short / BL Bone Level		
Art. No.	Image	Product
034.332		SP Profile Drill, short, Ø 3.3 mm, FIBA compatible
034.333		SP Profile Drill, short, Ø 4.1 mm, FIBA compatible
044.084		SP Profile Drill, short, Ø 4.8 mm, FIBA compatible
034.351		S/SP Tap, short, Ø 3.3 mm, FIBA compatible
034.352		S/SP Tap, short, Ø 4.1 mm, FIBA compatible
034.353		S/SP Tap, short, Ø 4.8 mm, FIBA compatible
046.708		SP/NNC Guided Adapter, for handpiece
046.710		SP/NNC Guided Adapter, for ratchet

\* Not all products are available in all countries. For further information, please refer to *Straumann® Dental Implant System, Basic information (702084/en)*.





# Order List: Standard Plus, Standard Plus Short, Bone Level Guided

## C MODULE - ORDER LIST

TLX/BLX Guided		
Art. No.	Image	Product
041.772		Straumann® Modular Cassette, C Module, Guided surgery
026.0147		Drill handle, Ø 2.2 mm, 1 mm/3 mm
026.0148		Drill handle, Ø 2.8 mm, 1 mm/3 mm
026.0150		Drill handle, Ø 3.5 mm, 1 mm/3 mm
026.0152		Drill handle, Ø 4.2 mm, 1 mm/3 mm
034.284		Drill for Template Fixation Pin, Ø 1.3 mm
034.282		Template Fixation Pin, Ø 1.3 mm
034.298		Template Fixation Pin, Ø 2.8/2.8 mm
034.285		Template Fixation Pin, Ø 5/2.8 mm
034.287		Template Fixation Pin, Ø 5/3.5 mm
034.289		Template Fixation Pin, Ø 5/4.2 mm



# A Module Set-up: Standard Plus, Standard Plus Short, Bone Level Guided

A Module  
041.761

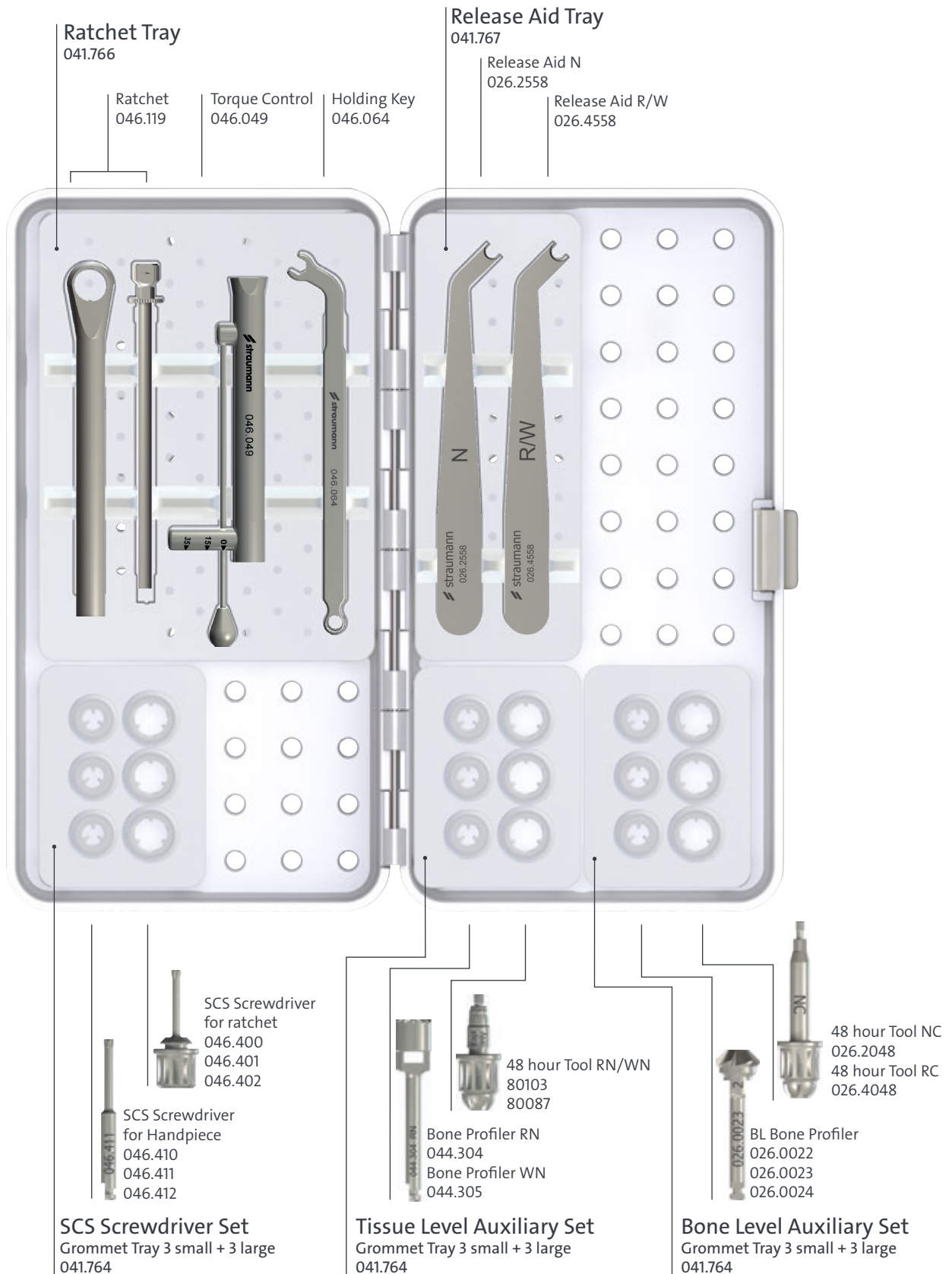



# B Module Set-up: Standard Plus, Standard Plus Short, Bone Level Guided

## Guided Parallel Walled Tray 041.782



Guided Adapter for profile drill  
034.354  
034.355  
034.356

Guided Adapter for tap  
034.357  
034.358  
034.359

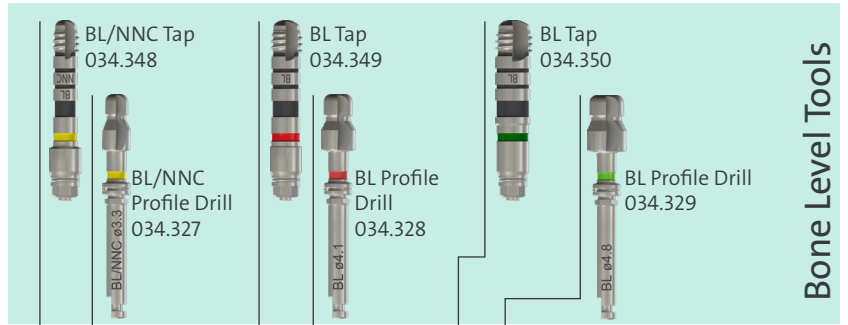

Bone Level Tools

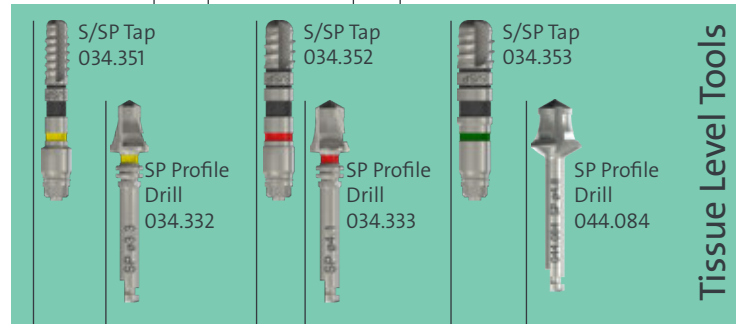

Tissue Level Tools

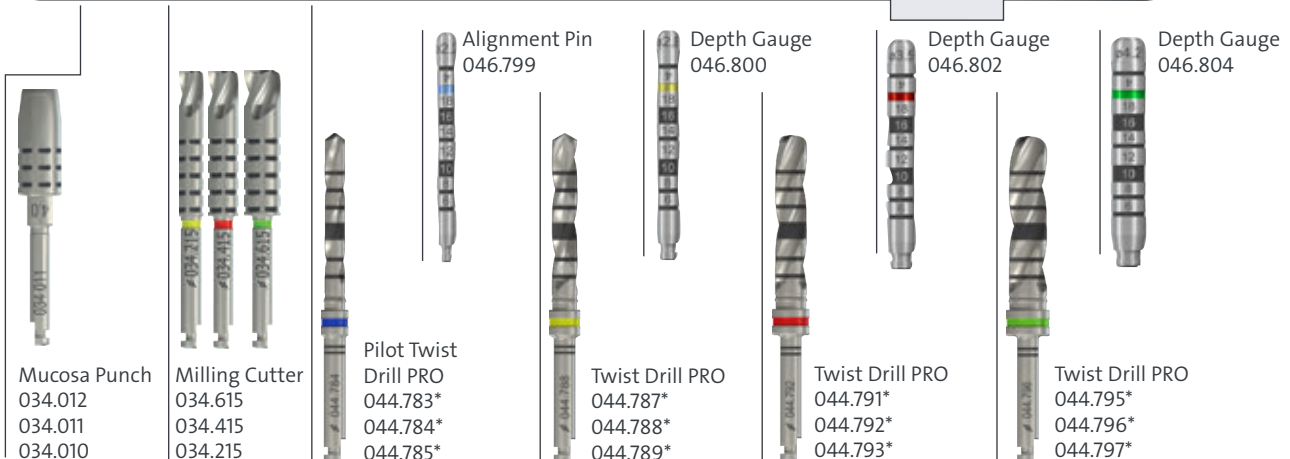
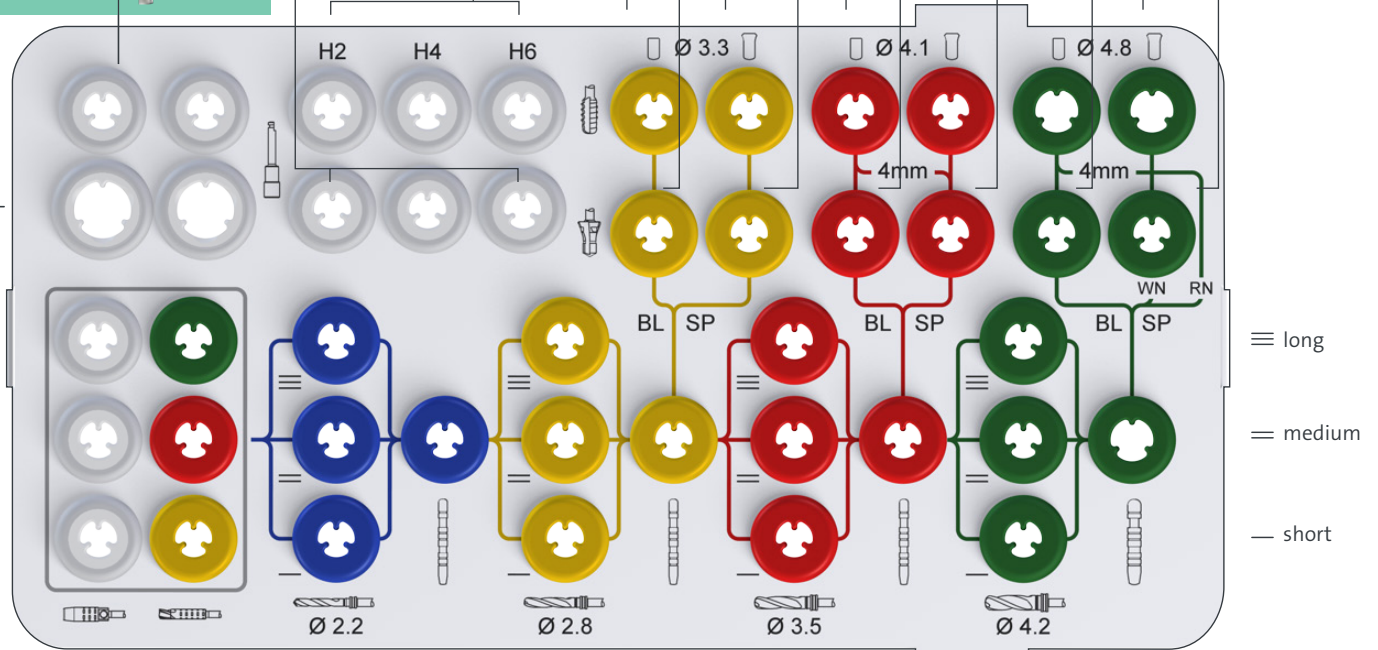

\* Not all products are available in all countries. For further information, please refer to Straumann® Dental Implant System, Basic information (702084/en).



# A Module Set-up: Standard Plus, Standard Plus Short, Bone Level Guided

C Module Guided Surgery  
041.772

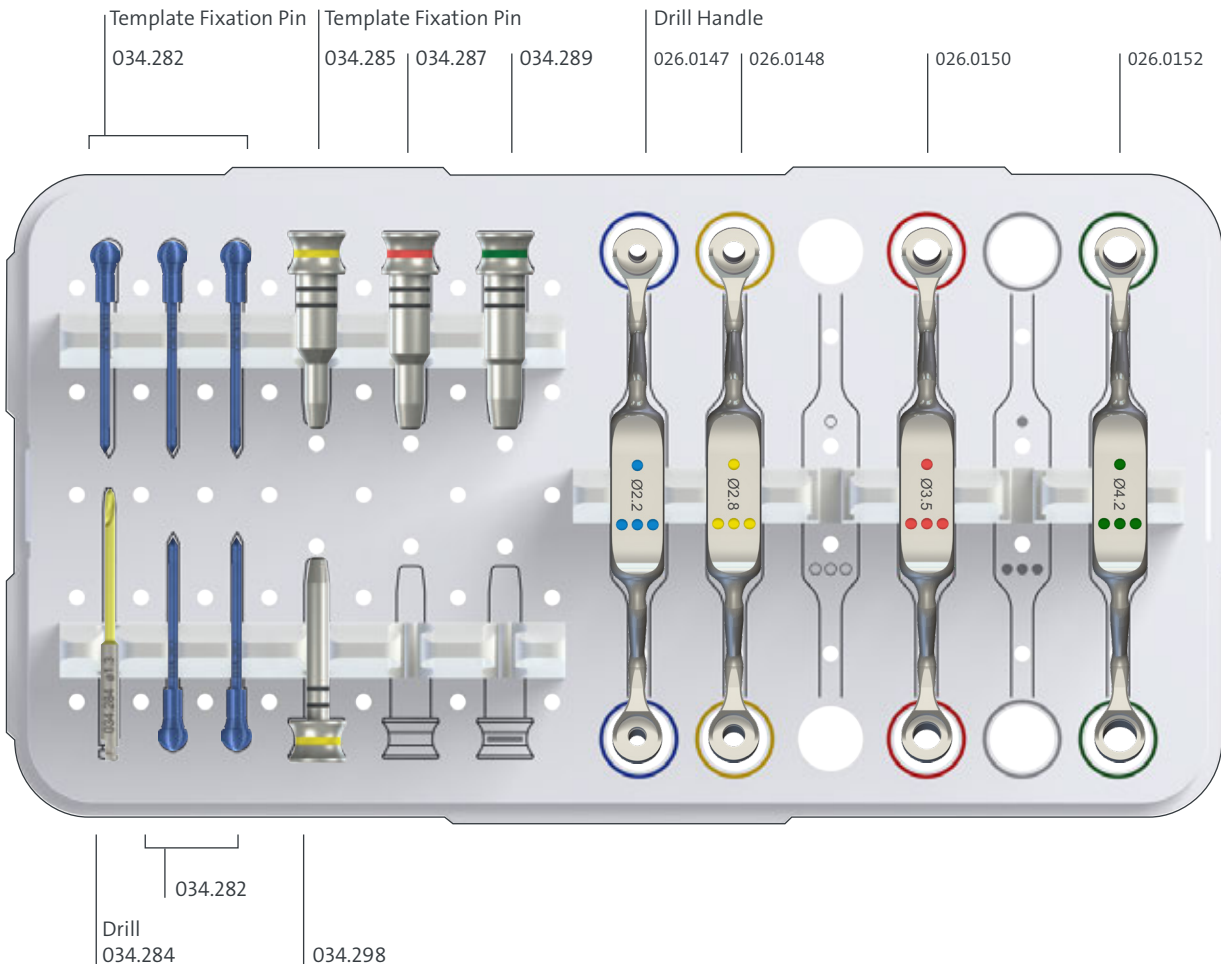



# Order List: Straumann® PURE Ceramic Implant System

## A MODULE - ORDER LIST

Straumann® PURE Ceramic Implant System		
Art. No.	Image	Product
041.761		Straumann® Modular Cassette, A Module
041.766		A Modul Ratchet Tray
046.119		Ratchet
046.049		Torque Control Device
046.064		Holding Key
041.764		Grommet Tray, 3 small + 3 large
046.400		SCS Screwdriver for Ratchet, extra-short
046.401		SCS Screwdriver for Ratchet, short
046.402		SCS Screwdriver for Ratchet, long
046.410		SCS Screwdriver for Handpiece, extra short
046.411		SCS Screwdriver for Handpiece, short
046.412		SCS Screwdriver for Handpiece, long
041.763		Grommet Tray, 6 large
031.080		48 hour Explantation Device, Straumann® PURE Ceramic Implant (Monotype) RD*
031.081		48 hour Explantation Device, Straumann® PURE Ceramic Implant (Monotype) ND*
032.053		48h Explantation Device, Straumann® PURE Ceramic Implant RD*

\* Note: PURE 48h explantation device are for single use only.

For additional tools (planning aid, tweezers, AS Screwdriver), please refer to page 4 *A Module full list*.

## B MODULE – ORDER LIST

Straumann® PURE Ceramic Implant System		
Art. No.	Image	Product
041.776		Straumann® Modular Cassette, B Module, Base + Lid
041.778		B Module, Basic Tray
040.563		Drill extender
044.003		Round bur, Ø2.3 mm
044.004		Round bur, Ø3.1 mm
026.0056		Needle drill long, Ø1.6 mm
044.783*		Pilot Twist Drill PRO, short, Ø2.2 mm
044.787*		Twist Drill PRO, short, Ø2.8 mm
044.791*		Twist Drill PRO, short, Ø3.5 mm
044.795*		Twist Drill PRO, short, Ø4.2 mm
044.785*		Pilot Twist Drill PRO, long, Ø2.2 mm
044.789*		Twist Drill PRO, long, Ø2.8 mm
044.793*		Twist Drill PRO, long, Ø3.5 mm
044.797*		Twist Drill PRO, long, Ø4.2 mm
034.327		BL/NNC Profile Drill, short, Ø3.3 mm, FIBA compatible
034.328		BL Profile Drill, short, Ø4.1 mm, FIBA compatible
034.329		BL Profile Drill, short, Ø4.8 mm, FIBA compatible
034.348		BL/NNC Tap, short, Ø3.3 mm, FIBA compatible
034.349		BL Tap, short, Ø4.1 mm, FIBA compatible
034.350		BL Tap, short, Ø4.8 mm, FIBA compatible

046.799		Alignment Pin, Ø2.2 mm, BLT
046.800		Depth Gauge, Ø2.8 mm, BLT
046.802		Depth Gauge, Ø3.5 mm, BLT
046.804		Depth Gauge, Ø4.2 mm, BLT
046.460		Adapter for Ratchet, extra-short
046.461		Adapter for Ratchet, short
046.470		Adapter for Handpiece, extra-short
046.471		Adapter for Handpiece, short

## C MODULE – ORDER LIST

Straumann® PURE Ceramic Implant System		
Art. No.	Image	Product
041.773		Straumann® Modular, Cassette, C Module, Spare Tools
031.102		Position Indicator, PURE ND, AH 4 mm, Ø2.2 mm
031.103		Position Indicator, PURE ND, AH 4 mm, Ø2.8 mm
031.112		Position Indicator, PURE ND, AH 5.5 mm, Ø2.2 mm
031.113		Position Indicator, PURE ND, AH 5.5 mm, Ø2.8 mm
031.123		Position Indicator, PURE RD, AH 4 mm, Ø2.2 mm
031.125		Position Indicator, PURE RD, AH 4 mm, Ø3.5 mm
031.143		Position Indicator, PURE RD, AH 5.5 mm, Ø2.2 mm
031.145		Position Indicator, PURE RD, AH 5.5 mm, Ø3.5 mm

\* Not all products are available in all countries. For further information, please refer to *Straumann® Dental Implant System, Basic information (702084/en)*.



# A Module Set-up: Straumann® PURE Ceramic Implant System

A Module  
041.761

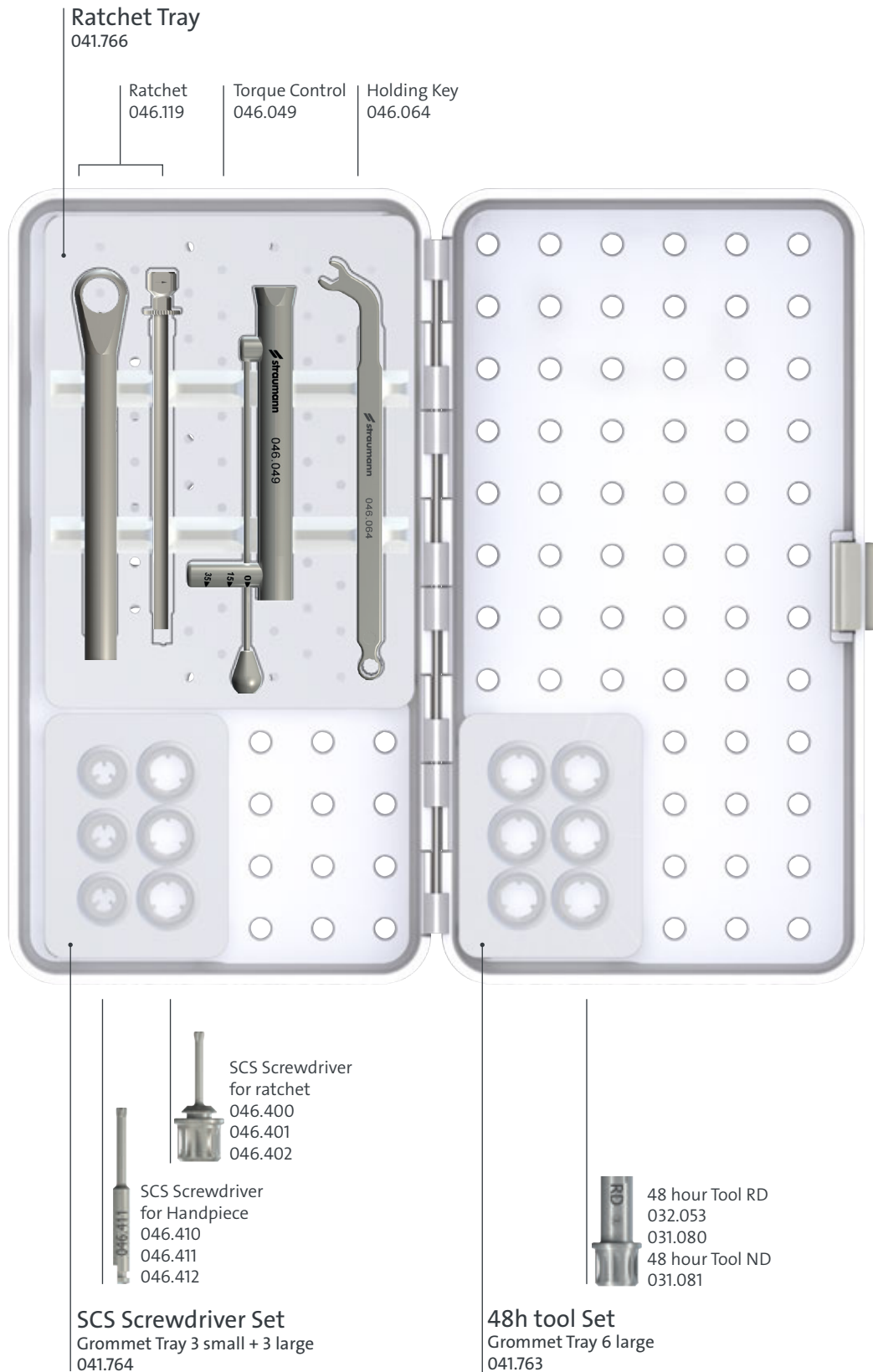



# B Module Set-up: Straumann® PURE Ceramic Implant System

## Basic Tray 041.778

**Adapter for Ratchet**  
046.460  
046.461

**Adapter for Handpiece**  
046.470  
046.471

**Drill Extender**  
040.563

**BL/NNC Tap**  
034.348

**BL Tap**  
034.349

**BL Tap**  
034.350

**BL/NNC Profile Drill**  
034.327

**BL Profile Drill**  
034.328

**BL Profile Drill**  
034.329

**Ø 2.9**

**Ø 3.3**

**Ø 4.1**

**Ø 4.8**

**long**

**short**

**Ø 3.1**

**Ø 2.3**

**Ø 1.6**

**Ø 2.2**

**Ø 2.8**

**Ø 3.5**

**Ø 4.2**

**Round Bur**  
044.004  
044.003

**Needle Drill**  
026.0056

**Pilot Twist Drill PRO**  
044.783\*  
044.785\*

**Twist Drill PRO**  
044.787\*  
044.789\*

**Alignment Pin**  
046.799

**Depth Gauge**  
046.800

**Depth Gauge**  
046.802

**Depth Gauge**  
046.804

**Twist Drill PRO**  
044.791\*  
044.793\*

**Twist Drill PRO**  
044.795\*  
044.797\*

\* Not all products are available in all countries. For further information, please refer to *Straumann® Dental Implant System, Basic information (702084/en)*.





# C Module Set-up: Straumann® PURE Ceramic Implant System

## C Module Spare Tools 041.773

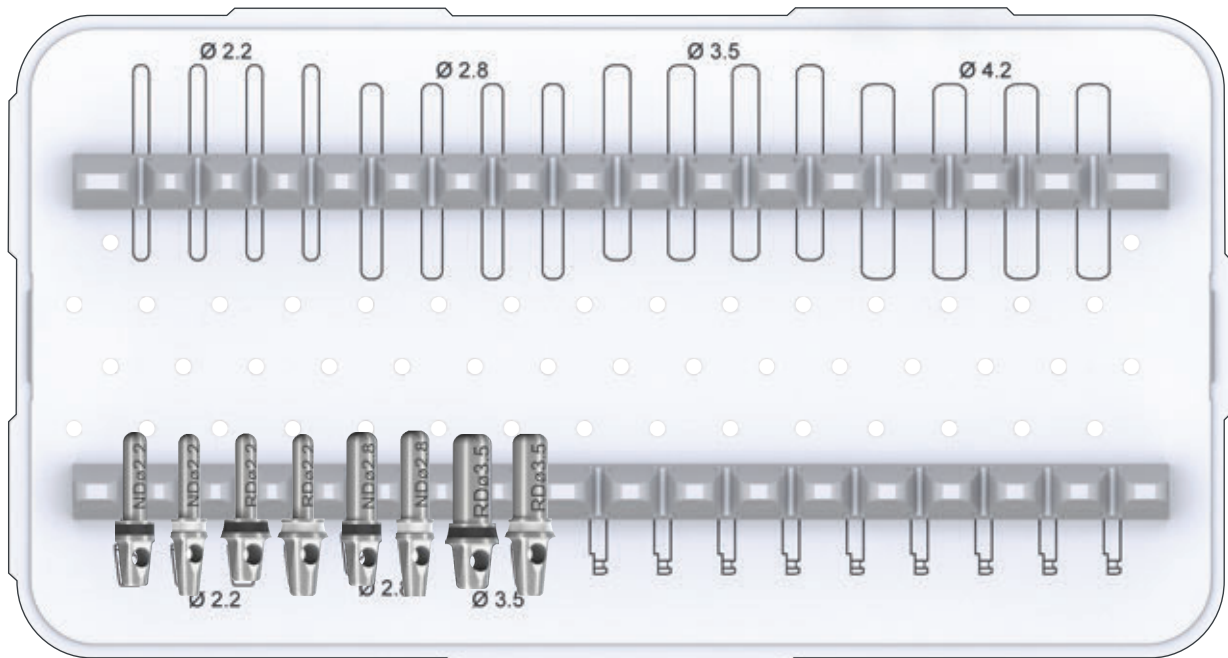

Position Indicator	031.103	031.125
031.102	031.113	031.145
031.112		
031.123		
031.143		

# BLT Order List: Bone Level Tapered

## A MODULE – ORDER LIST

BLT Bone Level Tapered		
Art. No.	Image	Product
041.761		Straumann® Modular Cassette, A Module
041.763		Grommet Tray, 6 large
026.2048		48 hour tool NC, BLT
026.4048		48 hour tool RC, BLT
041.766		A Modul Ratchet Tray
046.119		Ratchet
046.049		Torque Control Device
046.064		Holding Key
041.767		Release Aid Tray
026.2558		Release Aid N for Loxim®
026.4558		Release Aid R/W for Loxim®
041.764		Grommet Tray, 3 small + 3 large
046.400		SCS Screwdriver for Ratchet, extra-short
046.401		SCS Screwdriver for Ratchet, short
046.402		SCS Screwdriver for Ratchet, long
046.410		SCS Screwdriver for Handpiece, extra-short
046.411		SCS Screwdriver for Handpiece, short
046.412		SCS Screwdriver for Handpiece, long

041.762		Grommet Tray, 6 small
026.0022		BL Bone Profiler 1
026.0023		BL Bone Profiler 2
026.0024		BL Bone Profiler 3

## A MODULE BLT Ø 2.9 SPECIFIC TOOLS

Add for BLT Ø 2.9 implant line







BLT Bone Level Tapered Ø 2.9		
Art. No.	Image	Product
041.767		Release Aid Tray*
026.0073		Release Aid S for Loxim®
041.764		Grommet Tray, 3 small + 3 large*
026.0070		Bone Profiler, oval Platform, BLT SC*
026.0072		48 hour tool SC, BLT SC*
025.0042		SC Adapter for Handpiece, long, BLT SC*
025.0043		SC Adapter for Ratchet, long, BLT SC*













\* For Bone Level Tapered Small CrossFit® implant line only

For additional tools (planning aid, tweezers, AS Screwdriver), please refer to page 4 *A Module full list*.

# BLT Order List: Bone Level Tapered

## B MODULE - ORDER LIST

BLT Bone Level Tapered		
Art. No.	Image	Product
041.776		Straumann® Modular Cassette, B Module, Base + Lid
041.778		B Module, Basic Tray
040.563		Drill extender
044.003		Round bur, Ø2.3 mm
044.004		Round bur, Ø3.1 mm
026.0056		Needle drill, long, Ø1.6 mm
066.1301		X VeloDrill™, short, Ø2.2 mm
066.1302		X VeloDrill™, short, Ø2.8 mm
066.1304		X VeloDrill™, short, Ø3.5 mm
066.1306		X VeloDrill™, short, Ø4.2 mm
066.1701		X VeloDrill™, long, Ø2.2 mm
066.1702		X VeloDrill™, long, Ø2.8 mm
066.1704		X VeloDrill™, long, Ø3.5 mm
066.1706		X VeloDrill™, long, Ø4.2 mm
026.0061		BLT Profile Drill, short, Ø2.9 mm
034.324		BLT Profile Drill, short, Ø3.3 mm, FIBA compatible
034.325		BLT Profile Drill, short, Ø4.1 mm, FIBA compatible
034.326		BLT Profile Drill, short, Ø4.8 mm, FIBA compatible

026.0063		BLT Tap, long, Ø2.9 mm
034.345		BLT Tap, short, Ø3.3 mm, FIBA compatible
034.346		BLT Tap, short, Ø4.1 mm, FIBA compatible
034.347		BLT Tap, short, Ø4.8 mm, FIBA compatible
046.799		Alignment Pin, Ø2.2 mm
046.800		Depth Gauge, Ø2.8 mm
046.802		Depth Gauge, Ø3.5 mm
046.804		Depth Gauge, Ø4.2 mm
046.460		Adapter for Ratchet, extra-short
046.461		Adapter for Ratchet, short
046.470		Adapter for Handpiece, extra-short
046.471		Adapter for Handpiece, short

# BLT A Module Set-up: Bone Level Tapered

**A Module**  
041.761

**Ratchet Tray**  
041.766

Ratchet  
046.119

Torque Control  
046.049

Holding Key  
046.064

**Release Aid Tray**  
041.767

Release Aid N  
026.2558

Release Aid R/W  
026.4558

Release Aid S\*  
026.0073



SC Adapter\*  
for Ratchet  
025.0043



48 hour Tool SC\*  
026.0072

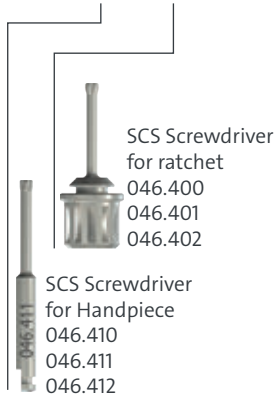

SCS Screwdriver  
for ratchet  
046.400  
046.401  
046.402

SCS Screwdriver  
for Handpiece  
046.410  
046.411  
046.412

**SCS Screwdriver Set**  
Grommet Tray 3 small + 3 large  
041.764



BL Bone Profiler  
026.0022  
026.0023  
026.0024

**Bone Profiler Set**  
Grommet Tray 6 small  
041.762



48 hour Tool  
NC/RC  
026.2048  
026.4048

**48h tool Set**  
Grommet Tray 6 large  
041.763



SC Adapter\* for  
Handpiece  
025.0042

Bone Profiler SC\*  
026.0070

**SC Auxiliary Set\***  
Grommet Tray 3 small + 3 large  
041.764

# BLT B Module Set-up: Bone Level Tapered

Basic Tray  
041.778

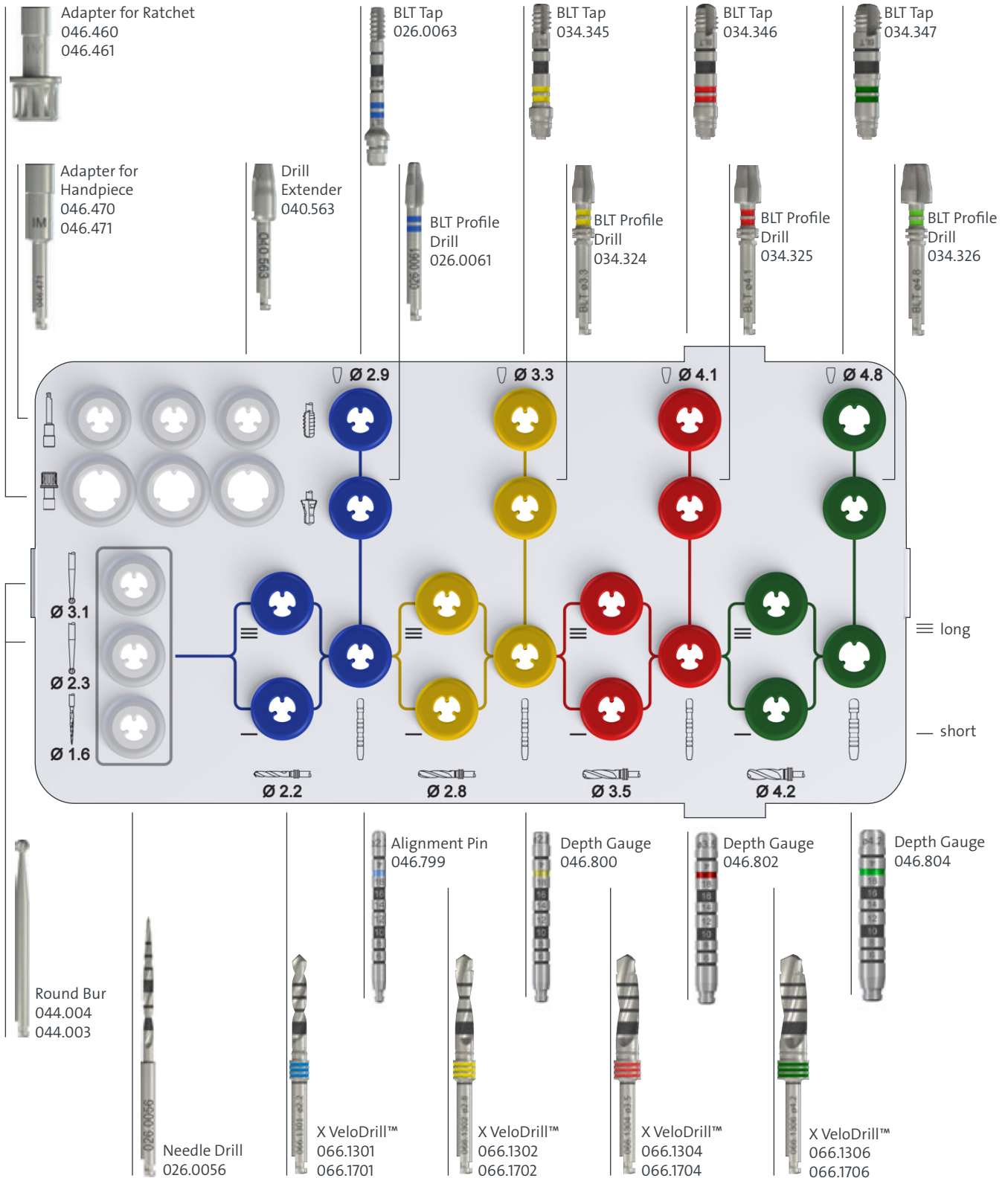

# BLT Order List: Bone Level Tapered Guided

## A MODULE – ORDER LIST

BLT Bone Level Tapered		
Art. No.	Image	Product
041.761		Straumann® Modular Cassette, A Module
041.763		Grommet Tray, 6 large
026.2048		48 hour tool NC, BLT
026.4048		48 hour tool RC, BLT
041.766		A Modul Ratchet Tray
046.119		Ratchet
046.049		Torque Control Device
046.064		Holding Key
041.767		Release Aid Tray
026.2558		Release Aid N for Loxim®
026.4558		Release Aid R/W for Loxim®
041.764		Grommet Tray, 3 small + 3 large
046.400		SCS Screwdriver for Ratchet, extra-short
046.401		SCS Screwdriver for Ratchet, short
046.402		SCS Screwdriver for Ratchet, long
046.410		SCS Screwdriver for Handpiece, extra-short
046.411		SCS Screwdriver for Handpiece, short
046.412		SCS Screwdriver for Handpiece, long

041.762		Grommet Tray, 6 small
026.0022		BL Bone Profiler 1
026.0023		BL Bone Profiler 2
026.0024		BL Bone Profiler 3

For additional tools (planning aid, tweezers, AS Screwdriver), please refer to page 4 *A Module full list*.











# BLT Order List: Bone Level Tapered Guided

## B MODULE - ORDER LIST

BLT Bone Level Tapered		
Art. No.	Image	Product
041.776		Straumann® Modular Cassette, B Module, Base + Lid
041.781		B Module, Guided Basic Tray
034.010		Mucosa Punch, Ø 3.4 mm
034.011		Mucosa Punch, Ø 4.0 mm
034.012		Mucosa Punch, Ø 4.7 mm
034.215		Milling Cutter, Ø 2.8 mm
034.415		Milling Cutter, Ø 3.5 mm
034.615		Milling Cutter, Ø 4.2 mm
066.1301		X VeloDrill™, short, Ø 2.2 mm
066.1302		X VeloDrill™, short, Ø 2.8 mm
066.1304		X VeloDrill™, short, Ø 3.5 mm
066.1306		X VeloDrill™, short, Ø 4.2 mm
066.1501		X VeloDrill™, medium, Ø 2.2 mm
066.1502		X VeloDrill™, medium, Ø 2.8 mm
066.1504		X VeloDrill™, medium, Ø 3.5 mm
066.1506		X VeloDrill™, medium, Ø 4.2 mm
066.1701		X VeloDrill™, long, Ø 2.2 mm
066.1702		X VeloDrill™, long, Ø 2.8 mm
066.1704		X VeloDrill™, long, Ø 3.5 mm
066.1706		X VeloDrill™, long, Ø 4.2 mm

034.354		Guided Adapter for profile drill, FIBA, H2
034.355		Guided Adapter for profile drill, FIBA, H4
034.356		Guided Adapter for profile drill, FIBA, H6
034.357		Guided Adapter for tap, H2
034.358		Guided Adapter for tap, H4
034.359		Guided Adapter for tap, H6
034.324		BLT Profile Drill, short, Ø 3.3 mm, FIBA compatible
034.325		BLT Profile Drill, short, Ø 4.1 mm, FIBA compatible
034.326		BLT Profile Drill, short, Ø 4.8 mm, FIBA compatible
034.345		BLT Tap, short, Ø 3.3 mm, FIBA compatible
034.346		BLT Tap, short, Ø 4.1 mm, FIBA compatible
034.347		BLT Tap, short, Ø 4.8 mm, FIBA compatible
046.799		Alignment Pin, Ø 2.2 mm
046.800		Depth Gauge, Ø 2.8 mm
046.802		Depth Gauge, Ø 3.5 mm
046.804		Depth Gauge, Ø 4.2 mm
026.0083		BL/BLT Guided Adapter, for handpiece
026.0084		BL/BLT Guided Adapter, for ratchet

## C MODULE – ORDER LIST

TLX/BLX Guided		
Art. No.	Image	Product
041.772		Straumann® Modular Cassette, C Module, Guided surgery
026.0147		Drill handle, Ø 2.2 mm, 1 mm/3 mm
026.0148		Drill handle, Ø 2.8 mm, 1 mm/3 mm
026.0150		Drill handle, Ø 3.5 mm, 1 mm/3 mm
026.0152		Drill handle, Ø 4.2 mm, 1 mm/3 mm
034.284		Drill for Template Fixation Pin, Ø 1.3 mm
034.282		Template Fixation Pin, Ø 1.3 mm
034.298		Template Fixation Pin, Ø 2.8/2.8 mm
034.285		Template Fixation Pin, Ø 5/2.8 mm
034.287		Template Fixation Pin, Ø 5/3.5 mm
034.289		Template Fixation Pin, Ø 5/4.2 mm



# BLT A Module Set-up: Bone Level Tapered Guided

A Module  
041.761

**Ratchet Tray**  
041.766

- Ratchet 046.119
- Torque Control 046.049
- Holding Key 046.064

**Release Aid Tray**  
041.767

- Release Aid N 026.2558
- Release Aid R/W 026.4558

**SCS Screwdriver Set**  
Grommet Tray 3 small + 3 large  
041.764

- SCS Screwdriver for ratchet 046.400, 046.401, 046.402
- SCS Screwdriver for Handpiece 046.410, 046.411, 046.412

**Bone Profiler Set**  
Grommet Tray 6 small  
041.762

- BL Bone Profiler 026.0022, 026.0023, 026.0024

**48h tool Set**  
Grommet Tray 6 large  
041.763

- 48 hour Tool NC/RC 026.2048, 026.4048

# BLT B Module Set-up: Bone Level Tapered Guided

## Guided Basic Tray 041.781

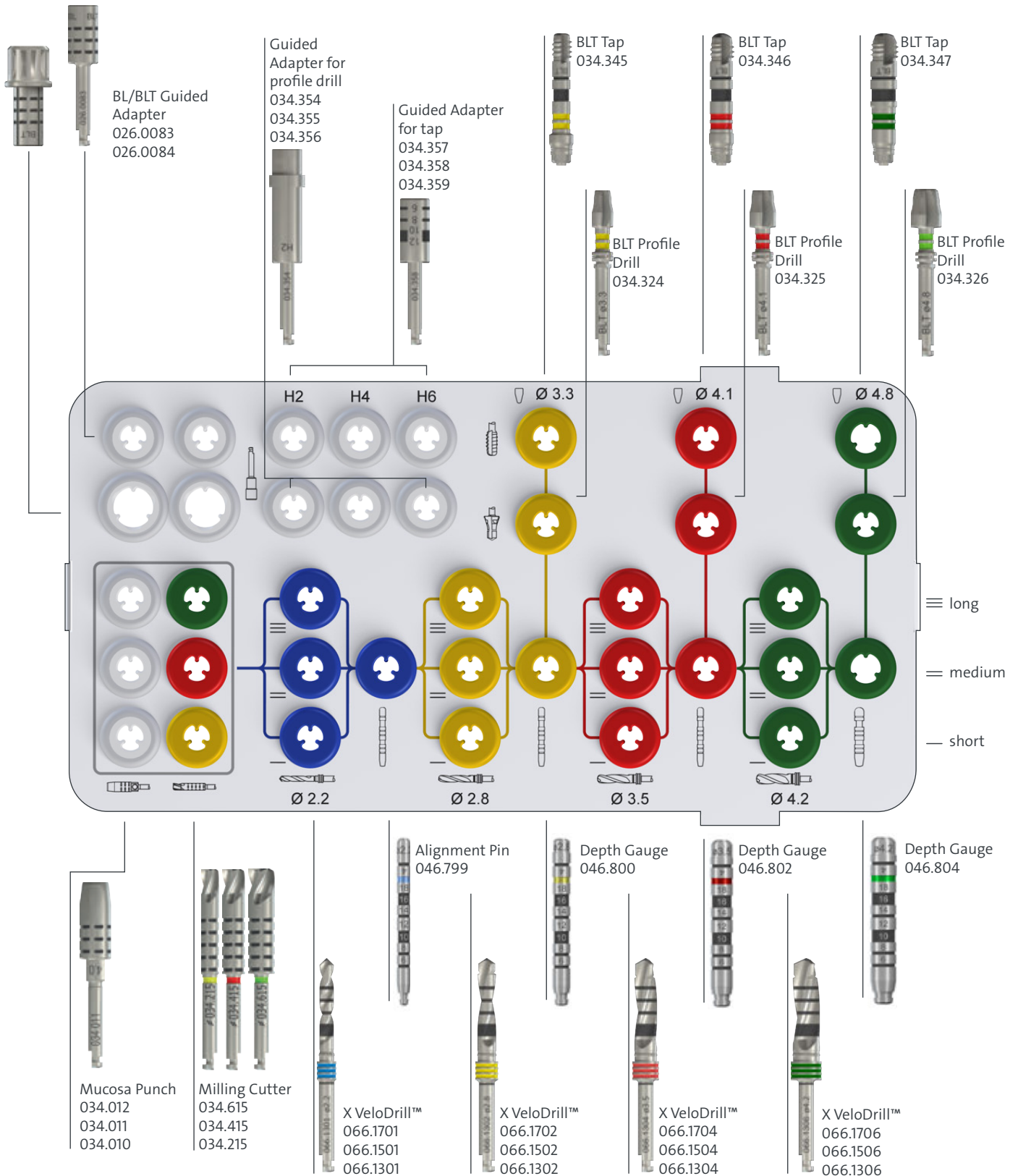

# BLT C Module Set-up: Bone Level Tapered Guided

C Module Guided Surgery  
041.772

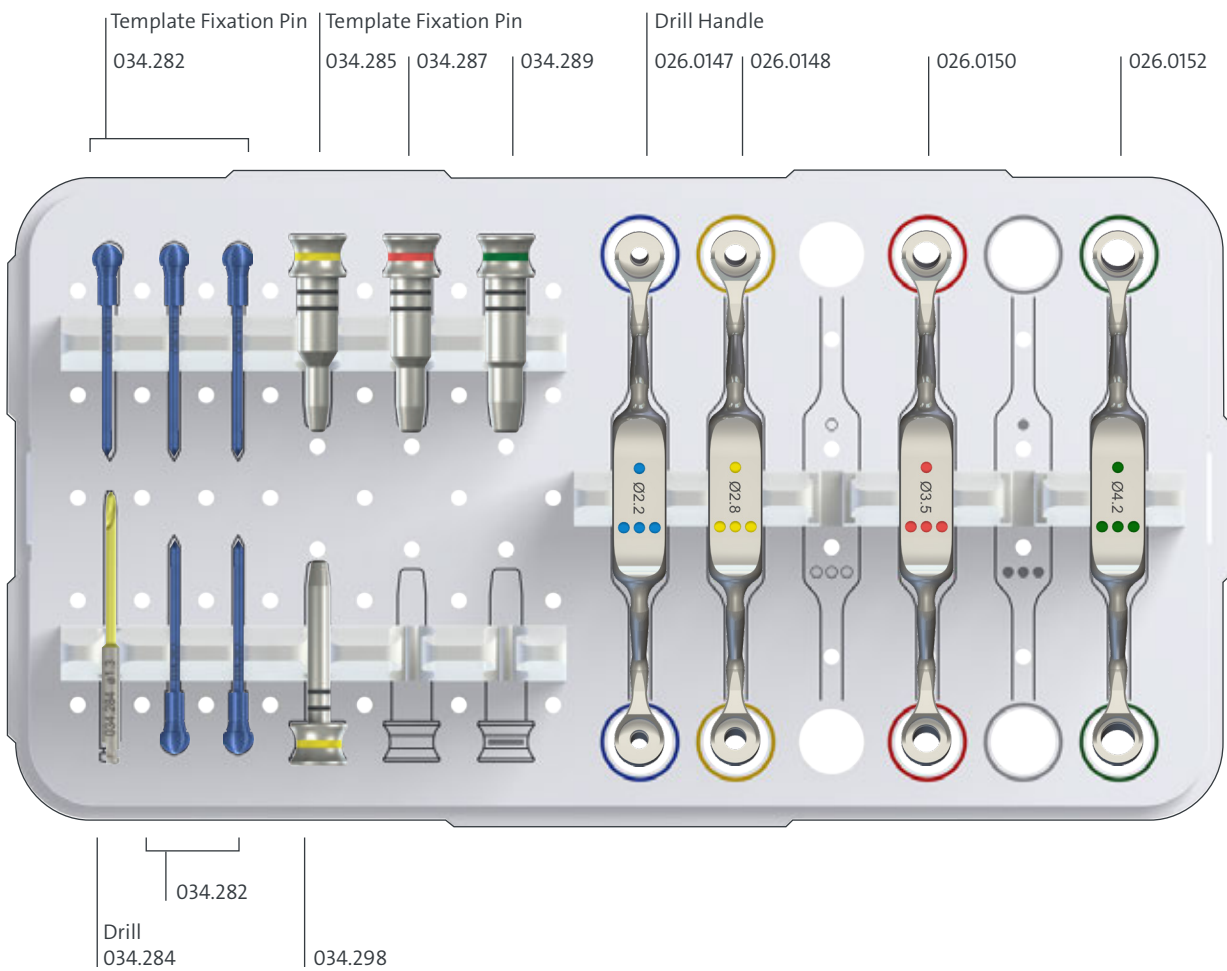

**A MODULE – ORDER LIST**

BLC/TLC		
Art. No.	Image	Product
041.761		Straumann® Modular Cassette, A Module
041.766		A Modul Ratchet Tray
046.119		Ratchet
066.1100		Torque Control Device
046.064		Holding Key
041.764		Grommet Tray, 3 small + 3 large
046.400		SCS Screwdriver for Ratchet, extra-short
046.401		SCS Screwdriver for Ratchet, short
046.402		SCS Screwdriver for Ratchet, long
046.410		SCS Screwdriver for Handpiece, extra-short
046.411		SCS Screwdriver for Handpiece, short
046.412		SCS Screwdriver for Handpiece, long
041.771		Implant Depth Gauge Tray
066.2000		Implant Depth Gauge

041.762		Grommet Tray, 6 small
026.0022		BL Bone Profiler 1
026.0023		BL Bone Profiler 2
026.0024		BL Bone Profiler 3
044.304		Bone Profiler RN/RT
044.305		Bone Profiler WN/WT
041.762		A Module, Grommet Tray, 6 small
036.3300		RT Profile Drill, short, for implants Ø 3.75/Ø 4.8 mm
036.3301		RT Profile Drill, long, for implants Ø 3.75/Ø 4.8 mm
036.3302		WT Profile Drill, short, for implants Ø 5.5/Ø 6.5 mm
036.3303		WT Profile Drill, long, for implants Ø 5.5/Ø 6.5 mm

For additional tools, tweezers, AS Screwdriver, please refer to page 4 *A Module full list*.

**B MODULE - ORDER LIST**

TLX/BLX		
Art. No.	Image	Product
041.776		Straumann® Modular Cassette, B Module, Base + Lid
041.787		B Module, TorcFit™ BLC/TLC/BLX/TLX Tray
044.003		Round bur, Ø 2.3 mm
044.004		Round bur, Ø 3.1 mm
026.0056		Needle drill, long, Ø 1.6 mm
066.1501		X VeloDrill™, medium, Ø 2.2 mm
066.1502		X VeloDrill™, medium, Ø 2.8 mm
066.1503		X VeloDrill™, medium, Ø 3.2 mm
066.1504		X VeloDrill™, medium, Ø 3.5 mm
066.1505		X VeloDrill™, medium, Ø 3.7 mm
066.1506		X VeloDrill™, medium, Ø 4.2 mm
066.1507		X VeloDrill™, medium, Ø 4.7 mm
066.1508		X VeloDrill™, medium, Ø 5.2 mm
066.1509		X VeloDrill™, medium, Ø 6.2 mm
034.362		BLC/TLC Profile Drill, short, Ø 3.3 mm, FIBA compatible
034.363		BLC/TLC Profile Drill, short, Ø 3.75 mm, FIBA compatible
034.365		BLC/TLC Profile Drill, short, Ø 4.5 mm, FIBA compatible
034.366		BLC/TLC Profile Drill, short, Ø 5.5 mm, FIBA compatible
034.367		BLC/TLC Profile Drill, short, Ø 6.5 mm, FIBA compatible

046.799		Alignment Pin, Ø 2.2 mm
046.800		Depth Gauge, Ø 2.8 mm
046.801		Depth Gauge, Ø 3.2 mm
046.802		Depth Gauge, Ø 3.5 mm
046.803		Depth Gauge, Ø 3.7 mm
046.804		Depth Gauge, Ø 4.2 mm
046.805		Depth Gauge, Ø 4.7 mm
046.806		Depth Gauge, Ø 5.2 mm
046.807		Depth Gauge, Ø 6.2 mm
066.4201		Implant driver for Ratchet, short
066.4207		Implant driver for Ratchet, medium
066.4202		Implant driver for Ratchet, long
066.4101		Implant driver for Handpiece, short
066.4107		Implant driver for Handpiece, medium
066.4102		Implant driver for Handpiece, long
040.563		Drill extender*
046.401		SCS Screwdriver for Ratchet, short
046.411		SCS Screwdriver for Handpiece, short

**Note:** The VeloDrills™ exist also in short (for 4-12 mm) implants and long (for 4-18 mm implants). According to the typical implant length placed, the tray can be set up with the preferred VeloDrill™ length.

\*The drill extender can be used to extend the drill in length by 14.5 mm.

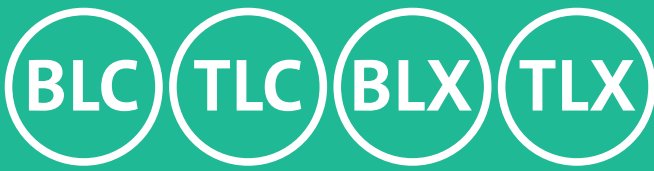

# A Module Set-up: Straumann® iEXCEL (BLX, TLX; BLC, TLC)

A Module  
041.761

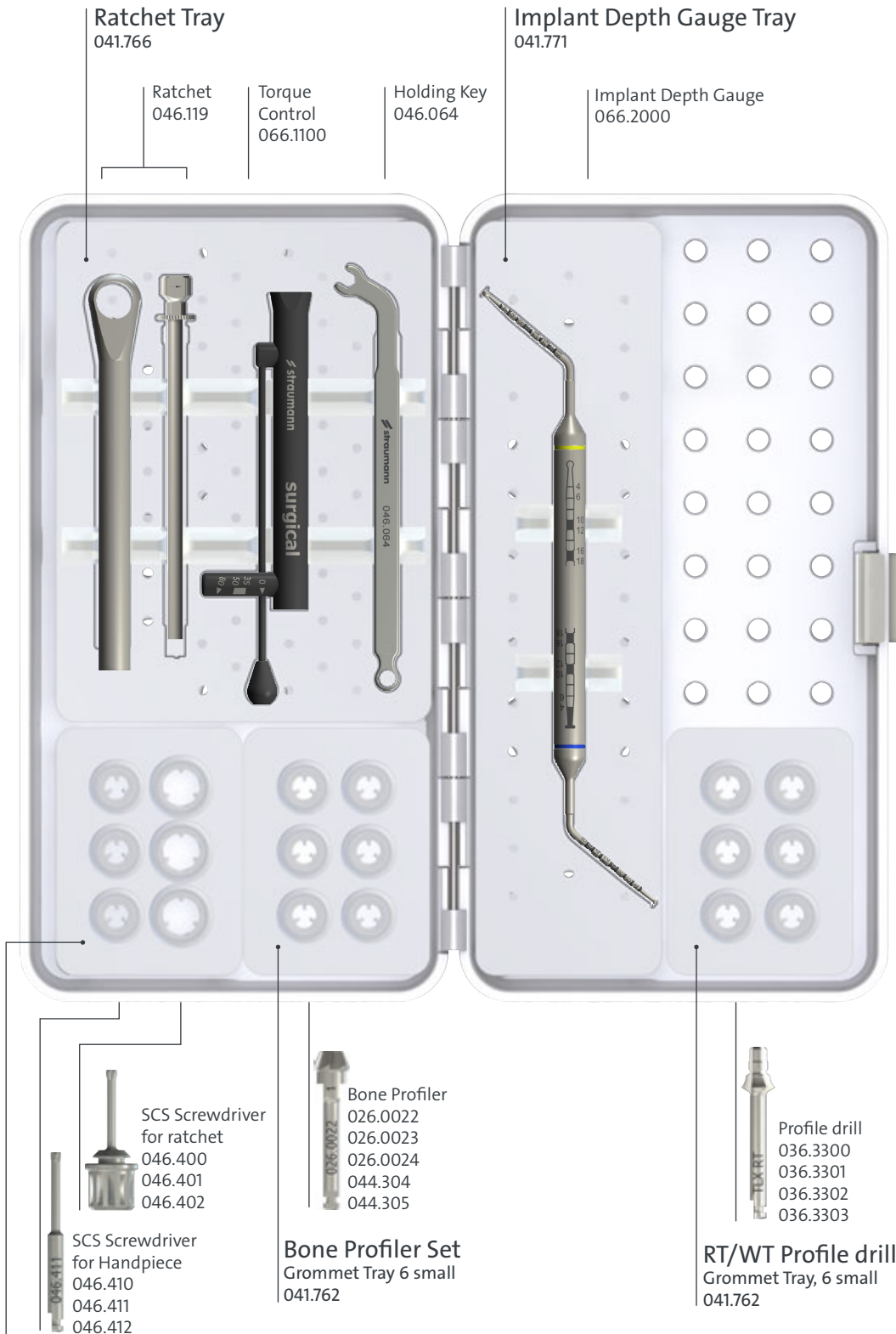

Ratchet Tray  
041.766

Ratchet  
046.119

Torque  
Control  
066.1100

Holding Key  
046.064

Implant Depth Gauge Tray  
041.771

Implant Depth Gauge  
066.2000

SCS Screwdriver  
for ratchet  
046.400  
046.401  
046.402

SCS Screwdriver  
for Handpiece  
046.410  
046.411  
046.412

Bone Profiler  
026.0022  
026.0023  
026.0024  
044.304  
044.305

Bone Profiler Set  
Grommet Tray 6 small  
041.762

Profile drill  
036.3300  
036.3301  
036.3302  
036.3303

RT/WT Profile drill set  
Grommet Tray, 6 small  
041.762

**Note:** Just for TLC/TLX  
submerged placement.

SCS Screwdriver Set  
Grommet Tray 3 small + 3 large  
041.764

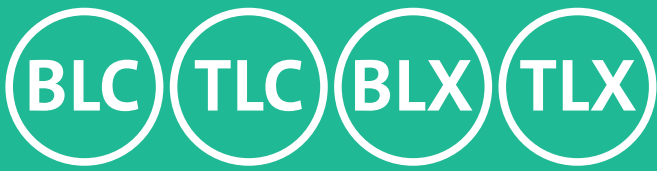

# B Module Set-up: Straumann® iEXCEL (BLX, TLX; BLC, TLC)

B Module, Tray TorcFit™ BLC, TLC, BLX, TLX  
041.787

**BLC/TLC Profile Drills**

- Profile Drill 034.362
- Profile Drill 034.363
- Profile Drill 034.365
- Profile Drill 034.366
- Profile Drill 034.367

**Alignment pin & depth gauges**

- Alignment pin 046.799
- Depth Gauge 046.800
- Depth Gauge 046.801
- Depth Gauge 046.802
- Depth Gauge 046.803
- Depth Gauge 046.804
- Depth Gauge 046.805
- Depth Gauge 046.806
- Depth Gauge 046.807

**Spare parts (optional)**

- SCS Screwdriver 046.401
- Drill Extender 040.563
- SCS Screwdriver for Handpiece 046.411

**Implant Driver for ratchet**  
066.4201  
066.4207  
066.4202

**Implant Driver for handpiece**  
066.4101  
066.4107  
066.4102

**Round Bur**  
044.003  
044.004

**Needle Drill**  
026.0056

**Needle Drills and Round Burs**

**VeloDrills™**

- 066.1701, 066.1501, 066.1301
- 066.1702, 066.1502, 066.1302
- 066.1703, 066.1503, 066.1303
- 066.1704, 066.1504, 066.1304
- 066.1705, 066.1505, 066.1305
- 066.1706, 066.1506, 066.1306
- 066.1507, 066.1307
- 066.1508, 066.1308
- 066.1509, 066.1309

**Spare parts**

**Profile Drills**

**QR code**

**Alignment Pin/Depth gauges**















**VeloDrills™**







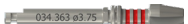



**Illustration for drill depth mark**

4 6 10 12 15 18

Choose one drill length between short, medium or long depending on the implant length used.

## B MODULE – ORDER LIST

BLC/TLC		
Art. No.	Image	Product
041.776		Straumann® Modular Cassette, B Module, Base + Lid
041.785		B Module, TorcFit™ BLC, TLC Tray
044.003		Round bur, Ø2.3 mm
044.004		Round bur, Ø3.1 mm
026.0056		Needle drill, long, Ø1.6 mm
066.1501		X VeloDrill™, medium, Ø2.2 mm
066.1502		X VeloDrill™, medium, Ø2.8 mm
066.1503		X VeloDrill™, medium, Ø3.2 mm
066.1504		X VeloDrill™, medium, Ø3.5 mm
066.1505		X VeloDrill™, medium, Ø3.7 mm
066.1506		X VeloDrill™, medium, Ø4.2 mm
034.362		BLC/TLC Profile Drill, short, Ø3.3 mm, FIBA compatible
034.363		BLC/TLC Profile Drill, short, Ø3.75 mm, FIBA compatible
034.365		BLC/TLC Profile Drill, short, Ø4.5 mm, FIBA compatible

046.799		Alignment Pin, Ø2.2 mm
046.800		Depth Gauge, Ø2.8 mm
046.801		Depth Gauge, Ø3.2 mm
046.802		Depth Gauge, Ø3.5 mm
046.803		Depth Gauge, Ø3.7 mm
046.804		Depth Gauge, Ø4.2 mm
066.4207		Implant driver for Ratchet, medium
066.4102		Implant driver for Handpiece, long
046.401		SCS Screwdriver for Ratchet, short
040.563		Drill extender*

**Note:** The VeloDrills™ exist also in short (for 4-12 mm) implants and long (for 4-18 mm implants). According to the typical implant length placed, the tray can be set up with the preferred VeloDrill™ length.

\*The drill extender can be used to extend the drill in length by 14.5 mm.



# BLC TLC B Module Set-up: BLC, TLC

B Module, TorcFit™ BLC, TLC Tray  
041.785

Profile Drill  
034.362

Profile Drill  
034.363

Profile Drill  
034.365

Implant Driver  
for ratchet  
066.4207

Implant Driver  
for handpiece  
066.4102



Alignment pin  
046.799



Depth Gauge  
046.800



Depth Gauge  
046.801



Depth Gauge  
046.802



Depth Gauge  
046.803



Depth Gauge  
046.804



SCS Screwdriver  
046.401



Drill Extender  
040.563

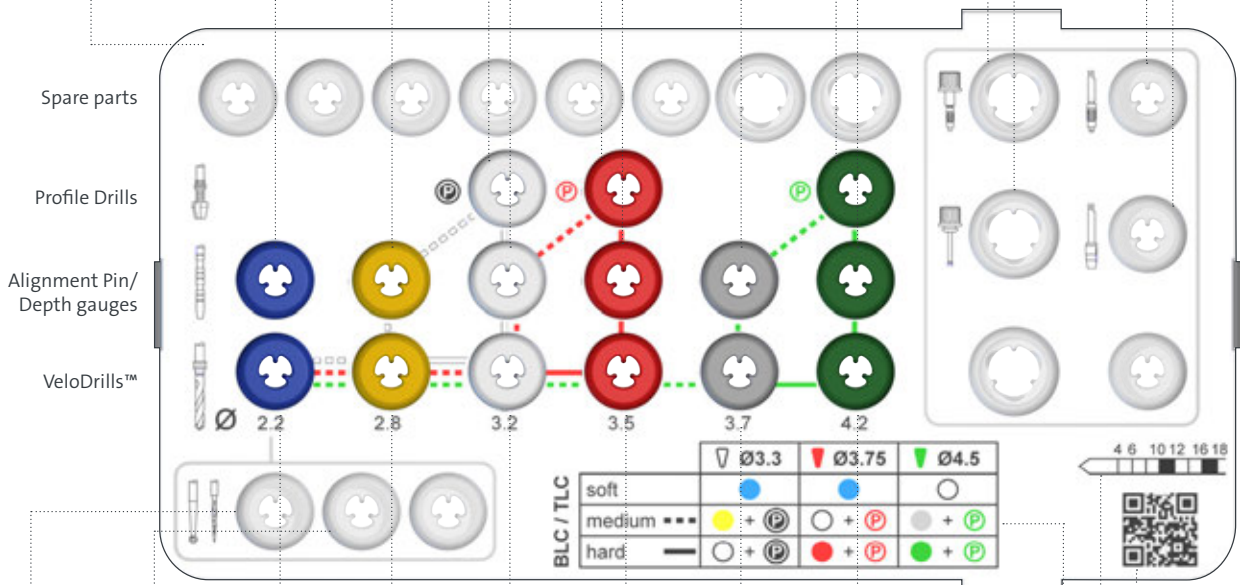

Needle Drill  
026.0056



Round Bur  
044.003  
044.004



X VeloDrill™  
066.1501



X VeloDrill™  
066.1502



X VeloDrill™  
066.1503



X VeloDrill™  
066.1504



X VeloDrill™  
066.1505



X VeloDrill™  
066.1506

QR code

Illustration  
for drill  
depth mark

Drilling protocol

**A MODULE – ORDER LIST**

BLC/TLC/TLX/BLX Guided		
Art. No.	Image	Product
041.761		Straumann® Modular Cassette, A Module
041.766		A Modul Ratchet Tray
046.119		Ratchet
066.1100		Torque Control Device
046.064		Holding Key
041.764		Grommet Tray, 3 small + 3 large
046.400		SCS Screwdriver for Ratchet, extra-short
046.401		SCS Screwdriver for Ratchet, short
046.402		SCS Screwdriver for Ratchet, long
046.410		SCS Screwdriver for Handpiece, extra-short
046.411		SCS Screwdriver for Handpiece, short
046.412		SCS Screwdriver for Handpiece, long
041.771		Implant Depth Gauge Tray
066.2000		Implant Depth Gauge
041.762		Grommet Tray, 6 small
026.0022		BL Bone Profiler 1
026.0023		BL Bone Profiler 2
026.0024		BL Bone Profiler 3
044.304		Bone Profiler RN/RT
044.305		Bone Profiler WN/WT

041.762		A Module, Grommet Tray, 6 small
036.3300		RT Profile Drill, short, for implants Ø 3.75/Ø 4.8 mm
036.3301		RT Profile Drill, long, for implants Ø 3.75/Ø 4.8 mm
036.3302		WT Profile Drill, short, for implants Ø 5.5/Ø 6.5 mm
036.3303		WT Profile Drill, long, for implants Ø 5.5/Ø 6.5 mm

For additional tools, tweezers, AS Screwdriver refer to page 4 *A Module full list.*

**B MODULE – ORDER LIST**

BLC/TLC/TLX/BLX Guided		
Art. No.	Image	Product
041.776		Straumann® Modular Cassette, B Module, Base + Lid
041.788		B Module TorcFit™ BLC/TLC/BLX/TLX Tray
034.010		Mucosa Punch, Ø 3.4 mm
034.011		Mucosa Punch, Ø 4.0 mm
034.012		Mucosa Punch, Ø 4.7 mm
034.215		Milling Cutter, Ø 2.8 mm
034.415		Milling Cutter, Ø 3.5 mm
034.615		Milling Cutter, Ø 4.2 mm
066.1301		X VeloDrill™, short, Ø 2.2 mm
066.1302		X VeloDrill™, short, Ø 2.8 mm
066.1303		X VeloDrill™, short, Ø 3.2 mm
066.1304		X VeloDrill™, short, Ø 3.5 mm
066.1305		X VeloDrill™, short, Ø 3.7 mm
066.1306		X VeloDrill™, short, Ø 4.2 mm
066.1307		X VeloDrill™, short, Ø 4.7 mm
066.1308		X VeloDrill™, short, Ø 5.2 mm
066.1309		X VeloDrill™, short, Ø 6.2 mm

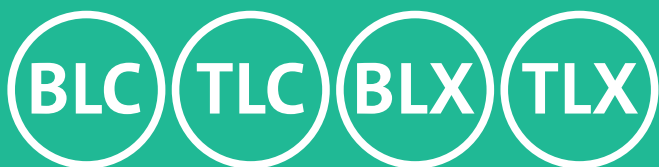

# Order List: Straumann® iEXCEL (BLX, TLX; BLC, TLC) Guided

066.1501		X VeloDrill™, medium, Ø2.2 mm
066.1502		X VeloDrill™, medium, Ø2.8 mm
066.1503		X VeloDrill™, medium, Ø3.2 mm
066.1504		X VeloDrill™, medium, Ø3.5 mm
066.1505		X VeloDrill™, medium, Ø3.7 mm
066.1506		X VeloDrill™, medium, Ø4.2 mm
066.1507		X VeloDrill™, medium, Ø4.7 mm
066.1508		X VeloDrill™, medium, Ø5.2 mm
066.1509		X VeloDrill™, medium, Ø6.2 mm
066.1701		X VeloDrill™, long, Ø2.2 mm
066.1702		X VeloDrill™, long, Ø2.8 mm
066.1703		X VeloDrill™, long, Ø3.2 mm
066.1704		X VeloDrill™, long, Ø3.5 mm
066.1705		X VeloDrill™, long, Ø3.7 mm
066.1706		X VeloDrill™, long, Ø4.2 mm
066.1707		X VeloDrill™, long, Ø4.7 mm
034.362		BLC/TLC Profile Drill, short, Ø3.3 mm, FIBA compatible
034.363		BLC/TLC Profile Drill, short, Ø3.75 mm, FIBA compatible
034.365		BLC/TLC Profile Drill, short, Ø4.5 mm, FIBA compatible
034.366		BLC/TLC Profile Drill, short, Ø5.5 mm, FIBA compatible
034.367		BLC/TLC Profile Drill, short, Ø6.5 mm, FIBA compatible
046.799		Alignment Pin, Ø2.2 mm
046.800		Depth Gauge, Ø2.8 mm
046.801		Depth Gauge, Ø3.2 mm
046.802		Depth Gauge, Ø3.5 mm
046.803		Depth Gauge, Ø3.7 mm
046.804		Depth Gauge, Ø4.2 mm
046.805		Depth Gauge, Ø4.7 mm
046.806		Depth Gauge, Ø5.2 mm
046.807		Depth Gauge, Ø6.2 mm

066.4404		BLC/BLX Guided implant Driver for Ratchet
066.4403		BLC/BLX Guided implant Driver for Handpiece
037.3000		TLC/TLX Guided Implant Driver for Ratchet, S
037.3001		TLC/TLX Guided Implant Driver for Handpiece, S
037.3002		TLC/TLX Guided Implant Driver for Ratchet, SP
037.3003		TLC/TLX Guided Implant Driver for Handpiece, SP

## C MODULE – ORDER LIST

BLC/TLC/TLX/BLX Guided		
Art. No.	Image	Product
041.772		Straumann® Modular Cassette, C Module, Guided surgery
026.0147		Drill handle, Ø2.2 mm, 1 mm/3 mm*
026.0148		Drill handle, Ø2.8 mm, 1 mm/3 mm*
026.0149		Drill handle, Ø3.2 mm, 1 mm/3 mm*
026.0150		Drill handle, Ø3.5 mm, 1 mm/3 mm*
026.0151		Drill handle, Ø3.7 mm, 1 mm/3 mm*
026.0152		Drill handle, Ø4.2 mm, 1 mm/3 mm*
034.284		Drill for Template Fixation Pin, Ø1.3 mm
034.282		Template Fixation Pin, Ø1.3 mm
034.298		Template Fixation Pin, Ø2.8/2.8 mm
034.285		Template Fixation Pin, Ø5/2.8 mm
034.286		Template Fixation Pin, Ø5/3.2 mm
034.287		Template Fixation Pin, Ø5/3.5 mm
034.288		Template Fixation Pin, Ø5/3.7 mm
034.289		Template Fixation Pin, Ø5/4.2 mm

\*Drill Handles compatible with metal sleeves, for the use with PEEK sleeves please use the self-locking handles with article numbers 034.291 - 034.296.

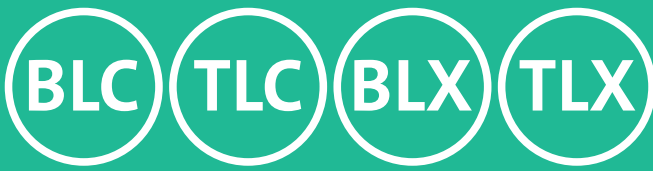

# A Module Set-up: Straumann® iEXCEL (BLX, TLX; BLC, TLC) Guided

A Module  
041.761

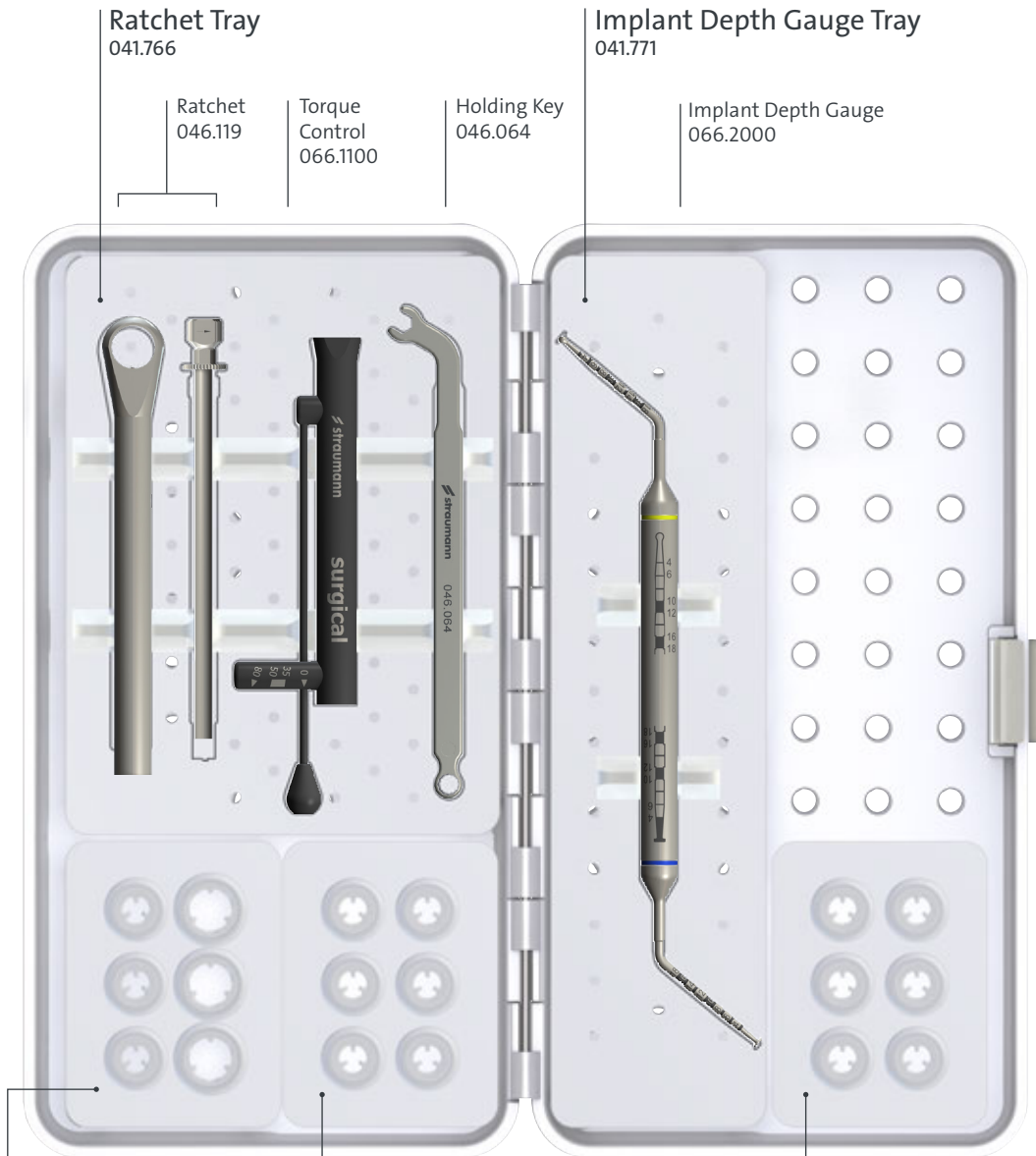

Ratchet Tray  
041.766

Ratchet  
046.119

Torque  
Control  
066.1100

Holding Key  
046.064

Implant Depth Gauge Tray  
041.771

Implant Depth Gauge  
066.2000

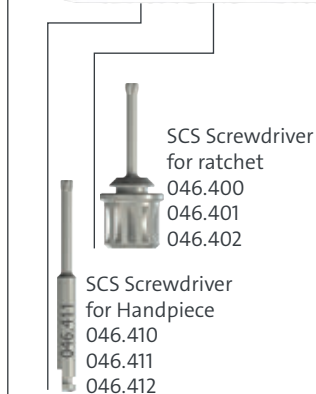

SCS Screwdriver  
for ratchet  
046.400  
046.401  
046.402

SCS Screwdriver  
for Handpiece  
046.410  
046.411  
046.412

SCS Screwdriver Set  
Grommet Tray 3 small + 3 large  
041.764

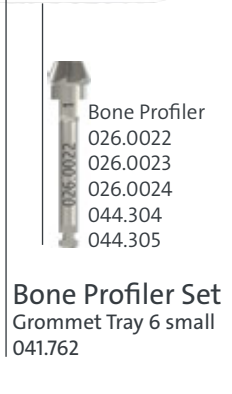

Bone Profiler  
026.0022  
026.0023  
026.0024  
044.304  
044.305

Bone Profiler Set  
Grommet Tray 6 small  
041.762

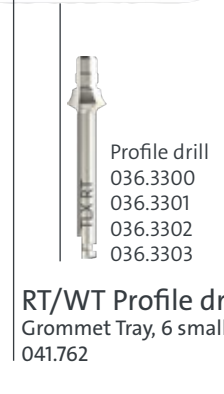

Profile drill  
036.3300  
036.3301  
036.3302  
036.3303

RT/WT Profile drill set  
Grommet Tray, 6 small  
041.762

**Note:** Just for TLC/TLX  
submerged placement.

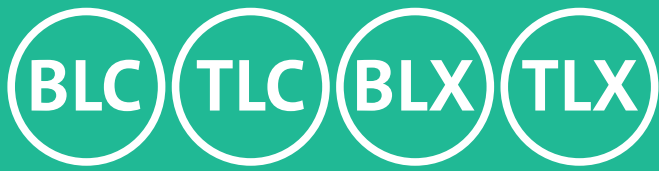

# B Module Set-up: Straumann® iEXCEL (BLX, TLX; BLC, TLC) Guided

B Module, Tray TorcFit™ BLC, TLC, BLX, TLX, Guided  
041.788

### Guided Implant Drivers



For ratchet:  
BLC/BLX,  
066.4404  
TLC/TLX S,  
037.3000  
TLC/TLX SP,  
037.3002



For handpiece:  
BLC/BLX,  
066.4403  
TLC/TLX S,  
037.3001  
TLC/TLX SP,  
037.3003

### BLC/TLC Profile Drills

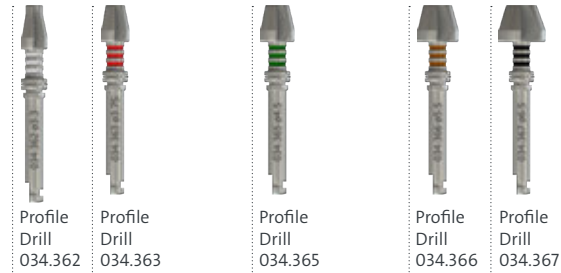

Profile Drill  
034.362

Profile Drill  
034.363

Profile Drill  
034.365

Profile Drill  
034.366

Profile Drill  
034.367

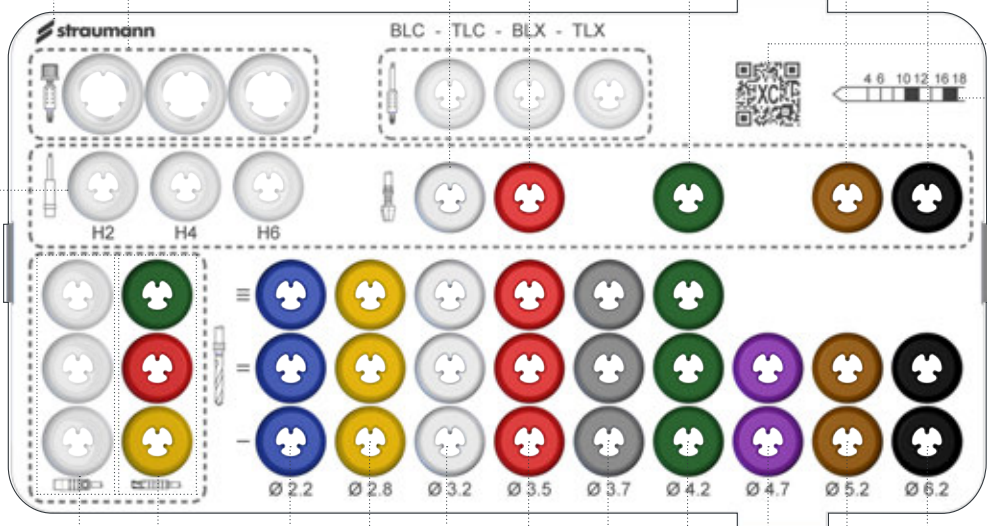

QR code  
Illustration for drill depth mark  
Profile Drills  
VeloDrills™

### Mucosa punches and milling cutters

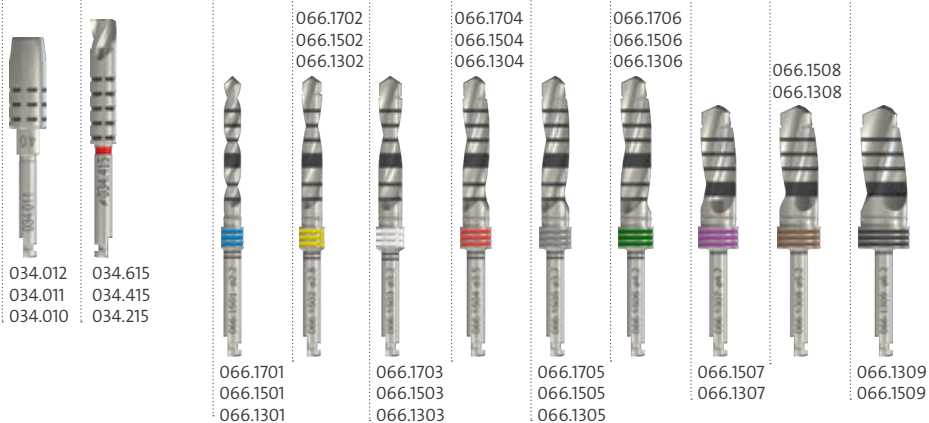

034.012 034.615  
034.011 034.415  
034.010 034.215

### VeloDrills™

066.1702 066.1704 066.1706 066.1508  
066.1502 066.1504 066.1506 066.1308  
066.1302 066.1304 066.1306

066.1701 066.1703 066.1705 066.1507 066.1309  
066.1501 066.1503 066.1505 066.1307 066.1509  
066.1301 066.1303 066.1305



# C Module Set-up: Straumann® iEXCEL (BLX, TLX; BLC, TLC) Guided

C Module Guided Surgery  
041.772

Template Fixation Pin			Template Fixation Pin			Drill Handle (metal T-Sleeve compatible)					
034.282	034.285	034.287	034.289	026.0147	026.0148	026.0149	026.0150	026.0151	026.0152		



034.282				
Drill	034.284	034.298	034.286	034.288

## A MODULE - ORDER LIST

TLX/BLX		
Art. No.	Image	Product
041.761		Straumann® Modular Cassette, A Module
041.766		A Modul Ratchet Tray
046.119		Ratchet
066.1100		Torque Control Device
046.064		Holding Key
041.764		Grommet Tray, 3 small + 3 large
046.400		SCS Screwdriver for Ratchet, extra-short
046.401		SCS Screwdriver for Ratchet, short
046.402		SCS Screwdriver for Ratchet, long
046.410		SCS Screwdriver for Handpiece, extra-short
046.411		SCS Screwdriver for Handpiece, short
046.412		SCS Screwdriver for Handpiece, long
041.771		Implant Depth Gauge Tray
066.2000		Implant Depth Gauge

041.762		Grommet Tray, 6 small
026.0022		BL Bone Profiler 1
026.0023		BL Bone Profiler 2
026.0024		BL Bone Profiler 3
044.304		Bone Profiler RN/RT
044.305		Bone Profiler WN/WT
041.762		A Module, Grommet Tray, 6 small
036.3300		RT Profile Drill, short, for implants Ø 3.75/Ø 4.8 mm
036.3301		RT Profile Drill, long, for implants Ø 3.75/Ø 4.8 mm
036.3302		WT Profile Drill, short, for implants Ø 5.5/Ø 6.5 mm
036.3303		WT Profile Drill, long, for implants Ø 5.5/Ø 6.5 mm

For additional tools, tweezers, AS Screwdriver, please refer to page 4 *A Module full list*.

## B MODULE – ORDER LIST

TLX/BLX		
Art. No.	Image	Product
041.776		Straumann® Modular Cassette, B Module, Base + Lid
041.777		B Module, Fully Tapered Tray
044.003		Round bur, Ø2.3 mm
044.004		Round bur, Ø3.1 mm
026.0056		Needle drill, long, Ø1.6 mm
066.1301		X VeloDrill™, short, Ø2.2 mm
066.1302		X VeloDrill™, short, Ø2.8 mm
066.1303		X VeloDrill™, short, Ø3.2 mm
066.1304		X VeloDrill™, short, Ø3.5 mm
066.1305		X VeloDrill™, short, Ø3.7 mm
066.1306		X VeloDrill™, short, Ø4.2 mm
066.1307		X VeloDrill™, short, Ø4.7 mm
066.1308		X VeloDrill™, short, Ø5.2 mm
066.1309		X VeloDrill™, short, Ø6.2 mm
066.1701		X VeloDrill™, long, Ø2.2 mm
066.1702		X VeloDrill™, long, Ø2.8 mm
066.1703		X VeloDrill™, long, Ø3.2 mm
066.1704		X VeloDrill™, long, Ø3.5 mm
066.1705		X VeloDrill™, long, Ø3.7 mm
066.1706		X VeloDrill™, long, Ø4.2 mm, BLX
066.1707		X VeloDrill™, long, Ø4.7 mm, BLX
046.799		Alignment Pin, Ø2.2 mm
046.800		Depth Gauge, Ø2.8 mm
046.801		Depth Gauge, Ø3.2 mm
046.802		Depth Gauge, Ø3.5 mm
046.803		Depth Gauge, Ø3.7 mm
046.804		Depth Gauge, Ø4.2 mm
046.805		Depth Gauge, Ø4.7 mm
046.806		Depth Gauge, Ø5.2 mm
046.807		Depth Gauge, Ø6.2 mm
066.4201		Implant driver for Ratchet, short
066.4207		Implant driver for Ratchet, medium
066.4202		Implant driver for Ratchet, long
066.4101		Implant driver for Handpiece, short
066.4107		Implant driver for Handpiece, medium
066.4102		Implant driver for Handpiece, long



# BLX TLX A Module Set-up: BLX, TLX

## A Module 041.761

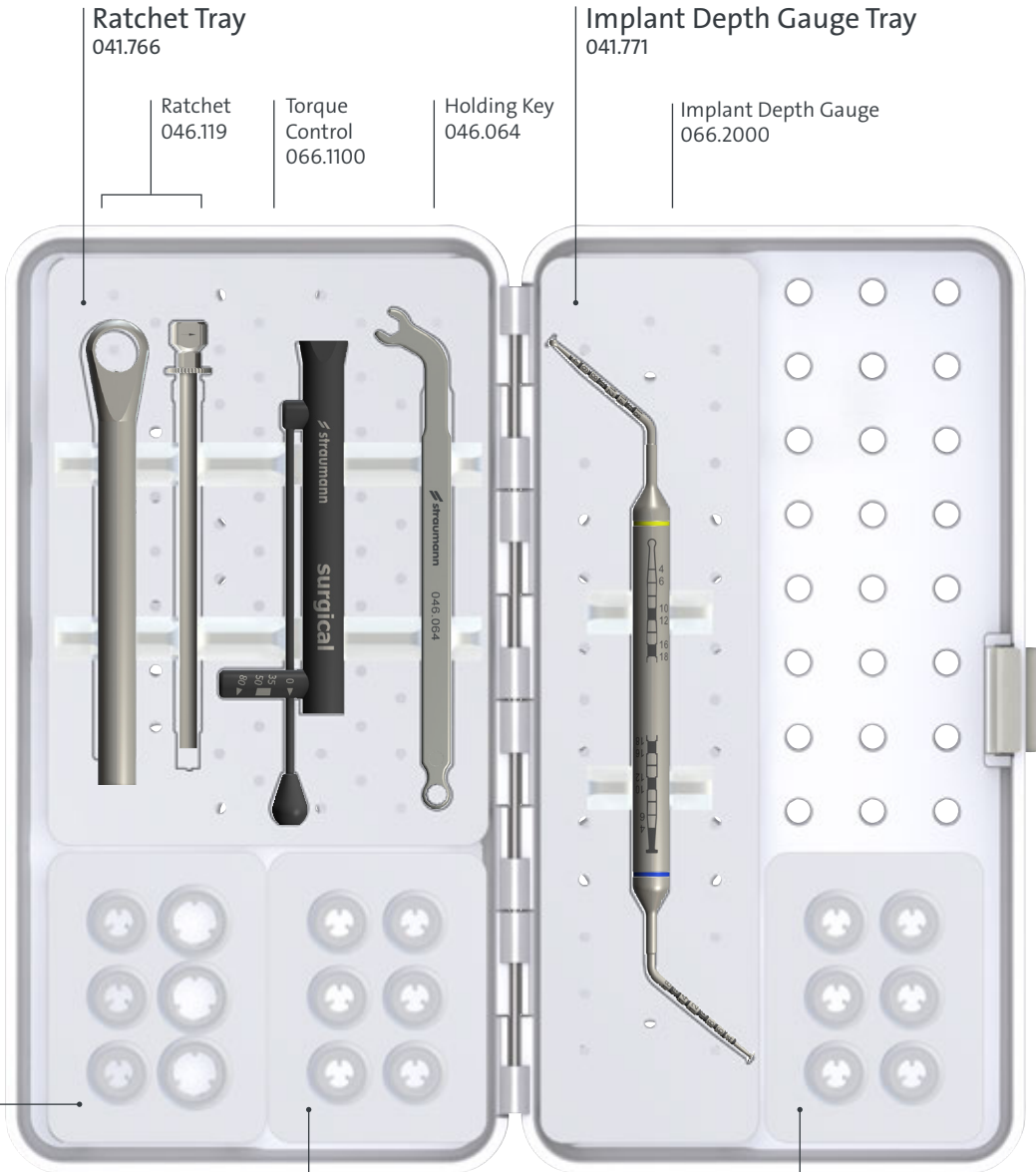

Ratchet Tray  
041.766

Ratchet  
046.119

Torque Control  
066.1100

Holding Key  
046.064

Implant Depth Gauge Tray  
041.771

Implant Depth Gauge  
066.2000



SCS Screwdriver  
for ratchet  
046.400  
046.401  
046.402

SCS Screwdriver  
for Handpiece  
046.410  
046.411  
046.412

SCS Screwdriver Set  
Grommet Tray 3 small + 3 large  
041.764



Bone Profiler  
026.0022  
026.0023  
026.0024  
044.304  
044.305

Bone Profiler Set  
Grommet Tray 6 small  
041.762



Profile drill  
036.3300  
036.3301  
036.3302  
036.3303

RT/WT Profile drill set  
Grommet Tray, 6 small  
041.762

**Note:** Just for TLX submerged placement.

# BLX TLX B Module Set-up: BLX, TLX

## Fully Tapered Tray 041.777

Implant Driver for Ratchet  
066.4201  
066.4207  
066.4202



Alignment Pin  
046.799



Depth Gauge  
046.801



Depth Gauge  
046.803



Depth Gauge  
046.805



Depth Gauge  
046.807



Implant Driver for Handpiece  
066.4101  
066.4107  
066.4102



Depth Gauge  
046.800



Depth Gauge  
046.802



Depth Gauge  
046.804



Depth Gauge  
046.806



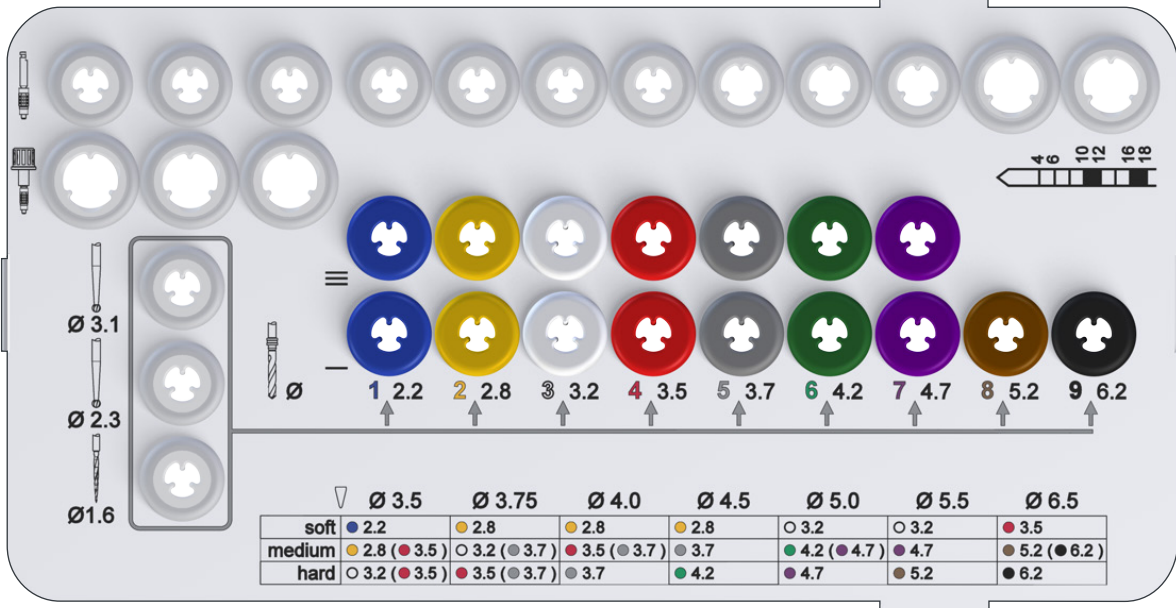

long

short

	Ø 3.5	Ø 3.75	Ø 4.0	Ø 4.5	Ø 5.0	Ø 5.5	Ø 6.5
soft	● 2.2	● 2.8	● 2.8	● 2.8	○ 3.2	○ 3.2	● 3.5
medium	● 2.8 (● 3.5)	○ 3.2 (● 3.7)	● 3.5 (● 3.7)	● 3.7	● 4.2 (● 4.7)	● 4.7	● 5.2 (● 6.2)
hard	○ 3.2 (● 3.5)	● 3.5 (● 3.7)	● 3.7	● 4.2	● 4.7	● 5.2	● 6.2

Round Bur  
044.004  
044.003



Needle Drill  
026.0056



X VeloDrill™  
066.1701  
066.1301



X VeloDrill™  
066.1702  
066.1302



X VeloDrill™  
066.1703  
066.1303



X VeloDrill™  
066.1704  
066.1304



X VeloDrill™  
066.1705  
066.1305



X VeloDrill™  
066.1706  
066.1306



X VeloDrill™  
066.1707  
066.1307



X VeloDrill™  
066.1308



X VeloDrill™  
066.1309



## A MODULE - ORDER LIST

TLX/BLX Guided		
Art. No.	Image	Product
041.761		Straumann® Modular Cassette, A Module
041.766		A Modul Ratchet Tray
046.119		Ratchet
066.1100		Torque Control Device
046.064		Holding Key
041.764		Grommet Tray, 3 small + 3 large
046.400		SCS Screwdriver for Ratchet, extra-short
046.401		SCS Screwdriver for Ratchet, short
046.402		SCS Screwdriver for Ratchet, long
046.410		SCS Screwdriver for Handpiece, extra-short
046.411		SCS Screwdriver for Handpiece, short
046.412		SCS Screwdriver for Handpiece, long
041.771		Implant Depth Gauge Tray
066.2000		Implant Depth Gauge
041.762		Grommet Tray, 6 small
026.0022		BL Bone Profiler 1
026.0023		BL Bone Profiler 2
026.0024		BL Bone Profiler 3
044.304		Bone Profiler RN/RT











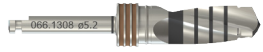







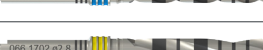











044.305		Bone Profiler WN/WT
041.762		A Module, Grommet Tray, 6 small
036.3300		RT Profile Drill, short, for implants Ø 3.75/Ø 4.8 mm
036.3301		RT Profile Drill, long, for implants Ø 3.75/Ø 4.8 mm
036.3302		WT Profile Drill, short, for implants Ø 5.5/Ø 6.5 mm
036.3303		WT Profile Drill, long, for implants Ø 5.5/Ø 6.5 mm

For additional tools, tweezers, AS Screwdriver refer to page 4 *A Module full list*.















## B MODULE - ORDER LIST

TLX/BLX Guided		
Art. No.	Image	Product
041.776		Straumann® Modular Cassette, B Module, Base + Lid
041.780		B Module, Fully Tapered Guided Tray
034.010		Mucosa Punch, Ø 3.4 mm
034.011		Mucosa Punch, Ø 4.0 mm
034.012		Mucosa Punch, Ø 4.7 mm
034.215		Milling Cutter, Ø 2.8 mm
034.415		Milling Cutter, Ø 3.5 mm
034.615		Milling Cutter, Ø 4.2 mm
066.1301		X VeloDrill™, short, Ø 2.2 mm
066.1302		X VeloDrill™, short, Ø 2.8 mm
066.1303		X VeloDrill™, short, Ø 3.2 mm
066.1304		X VeloDrill™, short, Ø 3.5 mm
066.1305		X VeloDrill™, short, Ø 3.7 mm
066.1306		X VeloDrill™, short, Ø 4.2 mm
066.1307		X VeloDrill™, short, Ø 4.7 mm

# BLX TLX Order List: BLX, TLX Guided

066.1308		X VeloDrill™, short, Ø 5.2 mm
066.1309		X VeloDrill™, short, Ø 6.2 mm
066.1501		X VeloDrill™, medium, Ø 2.2 mm
066.1502		X VeloDrill™, medium, Ø 2.8 mm
066.1503		X VeloDrill™, medium, Ø 3.2 mm
066.1504		X VeloDrill™, medium, Ø 3.5 mm
066.1505		X VeloDrill™, medium, Ø 3.7 mm
066.1506		X VeloDrill™, medium, Ø 4.2 mm
066.1701		X VeloDrill™, long, Ø 2.2 mm
066.1702		X VeloDrill™, long, Ø 2.8 mm
066.1703		X VeloDrill™, long, Ø 3.2 mm
066.1704		X VeloDrill™, long, Ø 3.5 mm
066.1705		X VeloDrill™, long, Ø 3.7 mm
066.1706		X VeloDrill™, long, Ø 4.2 mm
066.1707		X VeloDrill™, long, Ø 4.7 mm
046.799		Alignment Pin, Ø 2.2 mm
046.800		Depth Gauge, Ø 2.8 mm
046.801		Depth Gauge, Ø 3.2 mm
046.802		Depth Gauge, Ø 3.5 mm
046.803		Depth Gauge, Ø 3.7 mm
046.804		Depth Gauge, Ø 4.2 mm
046.805		Depth Gauge, Ø 4.7 mm
046.806		Depth Gauge, Ø 5.2 mm
046.807		Depth Gauge, Ø 6.2 mm
066.4403		BLX Guided implant Driver for Handpiece
066.4404		BLX Guided implant Driver for Ratchet
037.3000		TLX Guided Implant Driver for ratchet, S
037.3001		TLX Guided Implant Driver for handpiece, S
037.3002		TLX Guided Implant Driver for ratchet, SP
037.3003		TLX Guided Implant Driver for handpiece, SP

## C MODULE - ORDER LIST

TLX/BLX Guided		
Art. No.	Image	Product
041.772		Straumann® Modular Cassette, C Module, Guided surgery
026.0147		Drill handle, Ø 2.2 mm, 1 mm/3 mm*
026.0148		Drill handle, Ø 2.8 mm, 1 mm/3 mm*
026.0149		Drill handle, Ø 3.2 mm, 1 mm/3 mm*
026.0150		Drill handle, Ø 3.5 mm, 1 mm/3 mm*
026.0151		Drill handle, Ø 3.7 mm, 1 mm/3 mm*
026.0152		Drill handle, Ø 4.2 mm, 1 mm/3 mm*
034.284		Drill for Template Fixation Pin, Ø 1.3 mm
034.282		Template Fixation Pin, Ø 1.3 mm
034.298		Template Fixation Pin, Ø 2.8/2.8 mm
034.285		Template Fixation Pin, Ø 5/2.8 mm
034.286		Template Fixation Pin, Ø 5/3.2 mm
034.287		Template Fixation Pin, Ø 5/3.5 mm
034.288		Template Fixation Pin, Ø 5/3.7 mm
034.289		Template Fixation Pin, Ø 5/4.2 mm

\*Drill Handles compatible with metal sleeves, for the use with PEEK sleeves please use the self-locking handles with article numbers 034.291 - 034.296.

# BLX TLX A Module Set-up: BLX, TLX Guided

A Module  
041.761

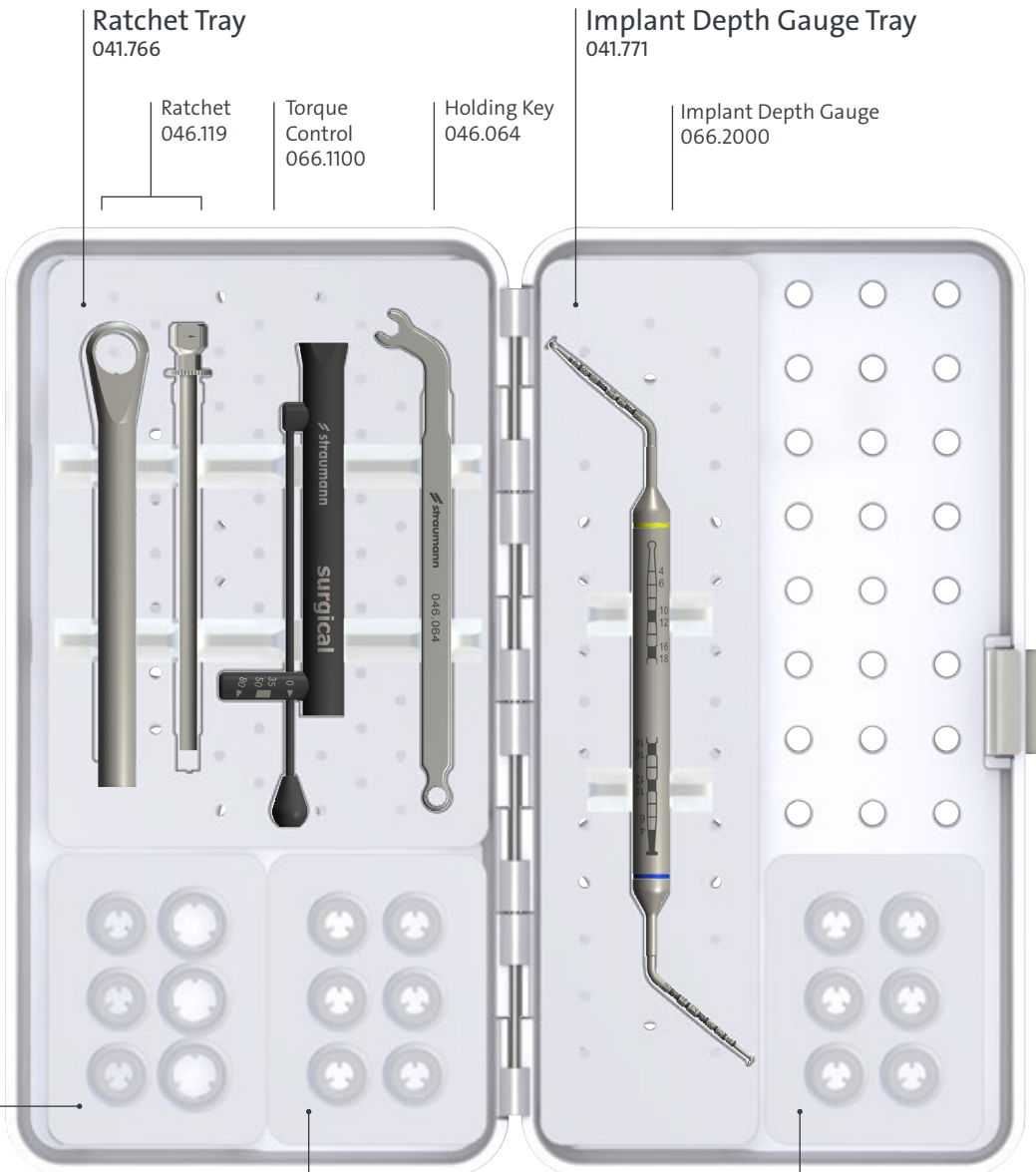

Ratchet Tray  
041.766

Ratchet  
046.119

Torque Control  
066.1100

Holding Key  
046.064

Implant Depth Gauge Tray  
041.771

Implant Depth Gauge  
066.2000



SCS Screwdriver  
for ratchet  
046.400  
046.401  
046.402

SCS Screwdriver  
for Handpiece  
046.410  
046.411  
046.412

SCS Screwdriver Set  
Grommet Tray 3 small + 3 large  
041.764



Bone Profiler  
026.0022  
026.0023  
026.0024  
044.304  
044.305

Bone Profiler Set  
Grommet Tray 6 small  
041.762



Profile drill  
036.3300  
036.3301  
036.3302  
036.3303

RT/WT Profile drill set  
Grommet Tray, 6 small  
041.762

**Note:** Just for TLX  
submerged placement.

# BLX TLX B Module Set-up: BLX, TLX Guided

## Fully Tapered Guided Tray 041.780

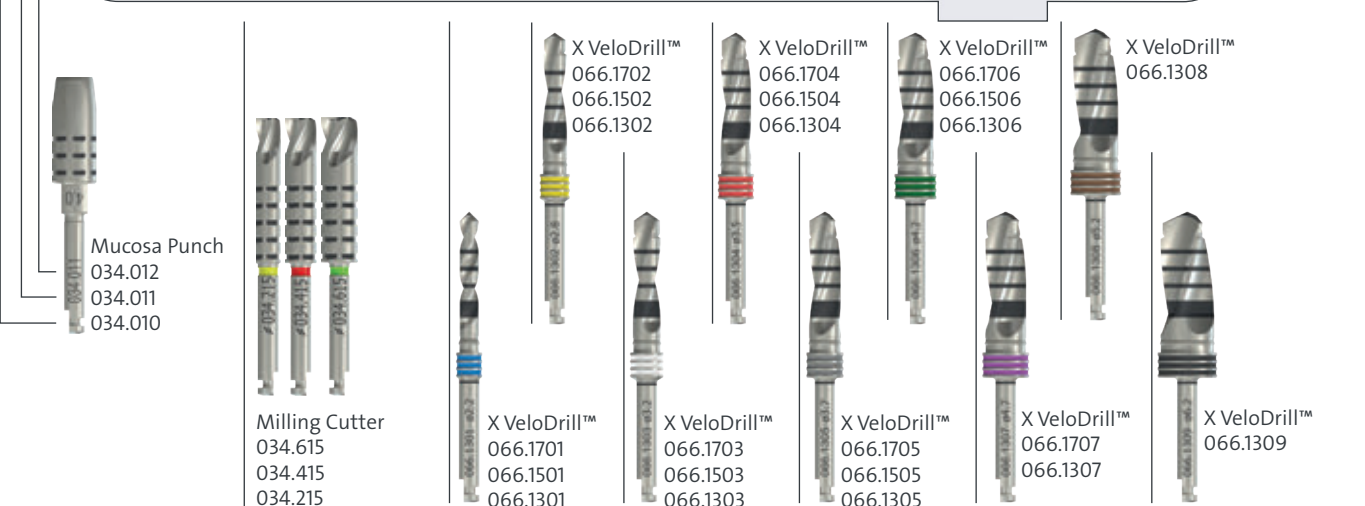
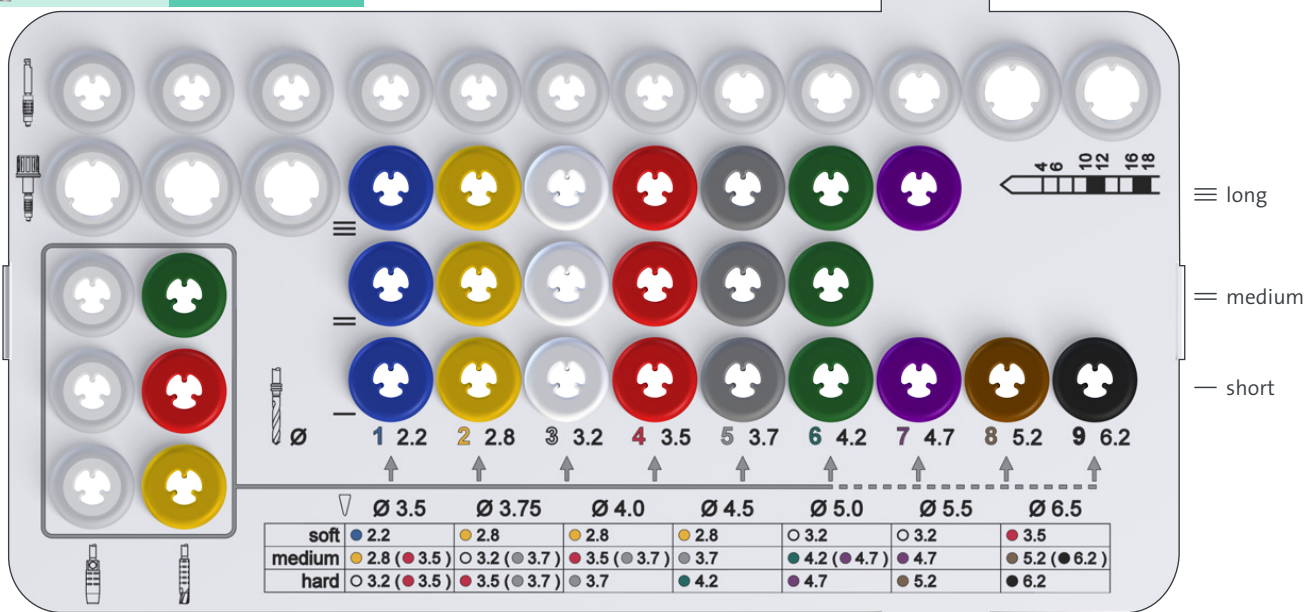
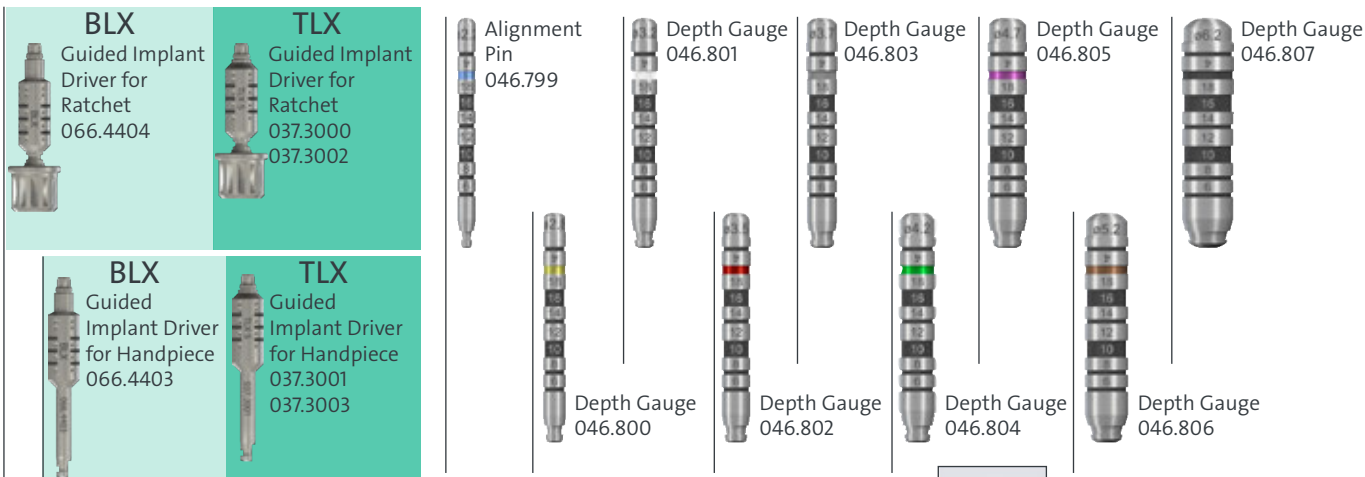

# BLX TLX C Module Set-up: BLX, TLX Guided

C Module Guided Surgery  
041.772

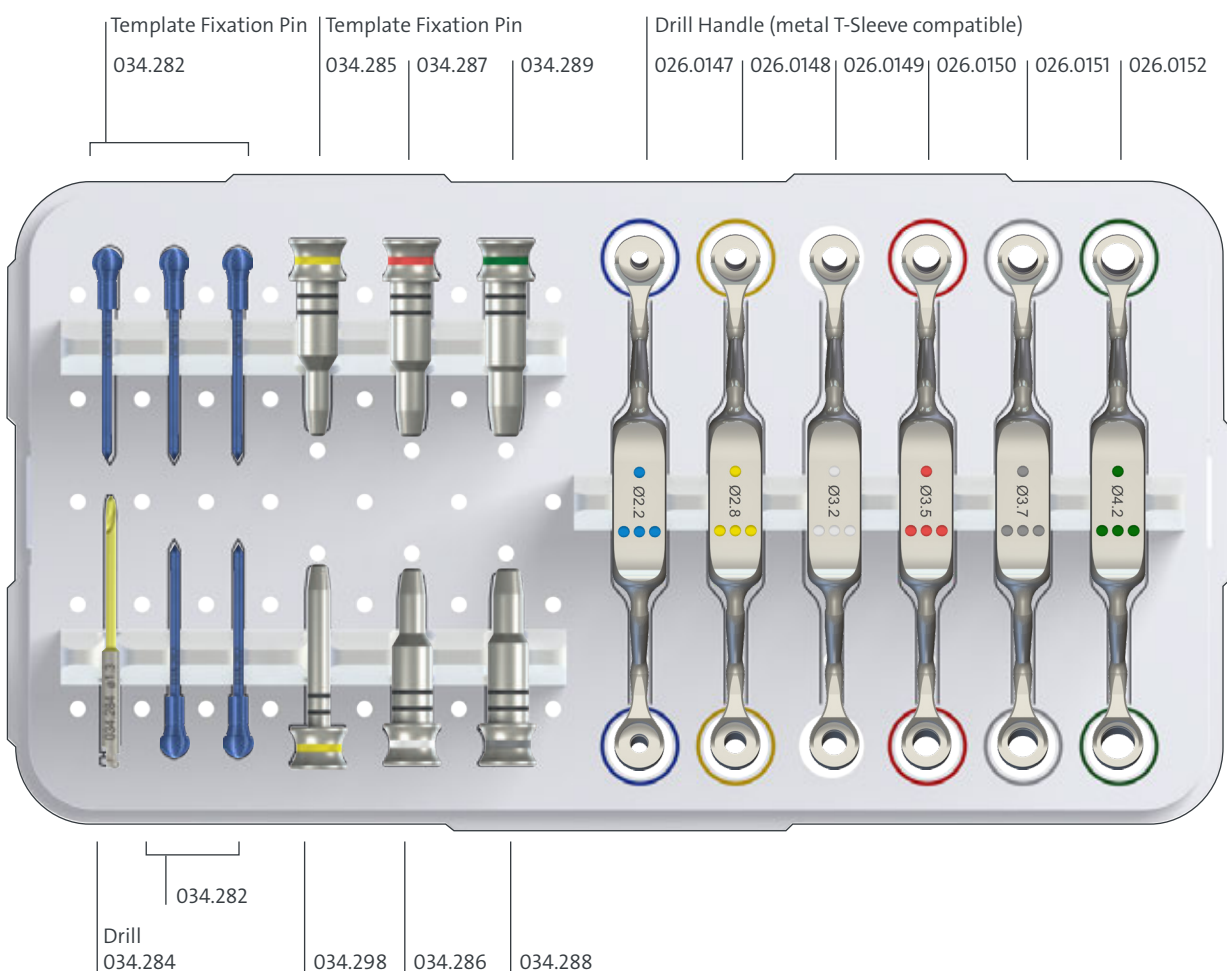



### International Headquarters

Institut Straumann AG  
Peter Merian-Weg 12  
CH-4002 Basel, Switzerland  
Phone +41 (0)61 965 11 11  
Fax +41 (0)61 965 11 01  
[www.straumann.com](http://www.straumann.com)

© Institut Straumann AG, 2024. All rights reserved.  
Straumann® and/or other trademarks and logos from Straumann® mentioned herein are the trademarks or registered trademarks of Straumann Holding AG and/or its affiliates.

